

MEASUREMENT REPORT

EMC Test Report

Applicant: Compex Systems Pte Ltd

Address: No:9 Harrison Road, Harrison Industrial Building, #05-01,
Singapore 369651

Product: 802.11ac Dual Band Module

Model No.: WLE600VX, WLE600VX-I

Brand Name: COMPEX

Standards: EN 301 489 - 1 V2.2.0 (2017-03)
EN 301 489 - 17 V3.2.0 (2017-03)

Result: Complies

Test Date: June 24 ~ July 11, 2017

Reviewed By : Jame Yuan
(Jame Yuan)

Approved By : Marlin Chen
(Marlin Chen)



The test results relate only to the samples tested.

The test results shown in the test report are traceable to the national/international standards through the calibration of the equipment and evaluated measurement uncertainty herein.

The test report shall not be reproduced except in full without the written approval of MRT Technology (Suzhou) Co., Ltd.

Revision History

Report No.	Version	Description	Issue Date	Note
1706RSU02401	Rev. 01	Initial report	07-11-2017	Valid

Note: The product has no change in hardware and software and only upgrades the EMC rules version as below. The was based on MRT Report number is 1503RSU02910 and we added the radiated emission & radio-frequency electromagnetic field testing, any others were same as before.

Old Rules Version	New Rules Version
ETSI EN 301 489 - 1 V1.9.2	ETSI EN 301 489 - 1 V2.2.0
ETSI EN 301 489 - 17 V2.2.1	ETSI EN 301 489 - 17 V3.2.0

CONTENTS

Description	Page
1. General Information	4
1.1. Applicant.....	4
1.2. Manufacturer	4
1.3. Testing Facility	4
1.4. Feature of Equipment under Test.....	5
1.5. Standards Applicable for Testing	5
1.6. Performance Criteria.....	6
2. Test Configuration of Equipment under Test	12
2.1. Test Mode	12
2.2. Configuration of Tested System	12
2.3. Test System Details	12
2.4. Test Procedure	12
3. Test Summary	13
4. Radiated Emission	14
4.1. Limit of Radiated Emission	14
4.2. Test Setup	14
4.3. Test Procedure	16
4.4. Test Result.....	17
4.5. Test Photograph	21
5. Radio-Frequency Electromagnetic Field	22
5.1. Limit of Radio-Frequency Electromagnetic Field.....	22
5.2. Test Setup	22
5.3. Test Procedure	23
5.4. Test Result.....	24
5.5. Test Photograph	25
6. Uncertainty Measurement	26
7. List of Measuring Instrument	27
8. Appendix - Original Report	29

1. General Information

1.1. Applicant

Compex Systems Pte Ltd

No:9 Harrison Road, Harrison Industrial Building, #05-01, Singapore 369651

1.2. Manufacturer

Compex Systems Pte Ltd

No:9 Harrison Road, Harrison Industrial Building, #05-01, Singapore 369651

1.3. Testing Facility

Test Site

MRT Technology (Suzhou) Co., Ltd

Test Site Location

D8 Building, No.2 Tian'edang Rd., Wuzhong Economic Development Zone, Suzhou, China

Test Facility / Accreditations

Measurements were performed at MRT Laboratory located in Tian'edang Rd., Suzhou, China.

- MRT facility is a FCC registered (MRT Reg. No. 809388) test facility with the site description report on file and has met all the requirements specified in Section 2.948 of the FCC Rules.
- MRT facility is an IC registered (MRT Reg. No. 11384A-1) test laboratory with the site description on file at Industry Canada.
- MRT facility is a VCCI registered (R-4179, G-814, C-4664, T-2206) test laboratory with the site description on file at VCCI Council.
- MRT Lab is accredited to ISO 17025 by the American Association for Laboratory Accreditation (A2LA) under the American Association for Laboratory Accreditation Program (A2LA Cert. No. 3628.01) in EMC, Telecommunications and Radio testing for FCC, Industry Canada, EU and TELEC Rules.



1.4. Feature of Equipment under Test

Product Name:	802.11ac Dual Band Module
Model No.:	WLE600VX, WLE600VX-I
Brand Name:	COMPEX
Frequency Range	<p><u>For 2.4GHz Band:</u> 802.11b/g/n: 2412 ~ 2472 MHz</p> <p><u>For 5GHz Band:</u> 802.11a/n/ac: 5150 ~ 5350MHz 5470 ~ 5725MHz 5725 ~ 5850MHz</p>
Type of Modulation	802.11b: DSSS 802.11g/a/n/ac: OFDM
Data Rate	802.11a: 6/9/12/18/24/36/48/54Mbps 802.11n: up to 300Mbps 802.11ac: up to 866.6Mbps

1.5. Standards Applicable for Testing

The EUT complies with the requirements of EN 301 489 - 1 V2.2.0 & ETSI EN 301 489 - 17 V3.2.0.

EMI Test:

EN 55032: 2015 (Radiated Emission)

EMS Test:

EN 61000-4-3: 2006+A1:2008+A2:2010 (RS)

1.6. Performance Criteria

General Requirements (ETSI EN 301489-1):

The performance criteria are used to take a decision on whether radio equipment passes or fails immunity tests.

For the purpose of the present document four categories of performance criteria apply:

- Performance criteria for continuous phenomena applied to transmitters and receivers;
- Performance criteria for transient phenomena applied to transmitters and receivers;
- Performance criteria for equipment which does not provide a continuous communication link;
- Performance criteria for ancillary equipment tested on a stand alone basis.

Normally, the performance criteria depend on the type of radio equipment. Thus, the present document only contains general performance criteria commonly used for the assessment of radio equipment. More specific and product-related performance criteria for a dedicated type of radio equipment may be found in the part of ETSI EN 301 489 series [i.13] dealing with the particular type of radio equipment.

Performance criteria for continuous phenomena applied to transmitters and receivers

If no further details are given in the relevant part of ETSI EN 301 489 series [i.13] dealing with the particular type of radio equipment, the following general performance criteria for continuous phenomena shall apply.

During and after the test, the equipment shall continue to operate as intended. No degradation of performance or loss of function is allowed below a permissible performance level specified by the manufacturer when the equipment is used as intended. In some cases this permissible performance level may be replaced by a permissible loss of performance.

During the test the EUT shall not unintentionally transmit or change its actual operating state and stored data.

If the minimum performance level or the permissible performance loss is not specified by the manufacturer, then either of these may be deduced from the product description and documentation and what the user may reasonably expect from the equipment if used as intended.

Performance criteria for transient phenomena applied to transmitters and receivers

If no further details are given in the relevant part of ETSI EN 301 489 series [i.13] dealing with the particular type of radio equipment, the following general performance criteria for transient phenomena shall apply.

For surges applied to symmetrically operated wired network ports intended to be connected directly to outdoor lines the following criteria applies:

- For products with only one symmetrical port intended for connection to outdoor lines, loss of function is allowed, provided the function is self-recoverable, or can be restored by the operation of the controls by the user in accordance with the manufacturer's instructions. A SW reboot is not allowed. Information stored in non-volatile memory, or protected by a battery backup, shall not be lost.
- For products with more than one symmetrical port intended for connection to outdoor lines, loss of function on the port under test is allowed, provided the function is self-recoverable. A SW reboot is not allowed. Information stored in non-volatile memory, or protected by a battery backup, shall not be lost.

For all other ports the following applies:

- After the test, the equipment shall continue to operate as intended. No degradation of performance or loss of function is allowed below a permissible performance level specified by the manufacturer, when the equipment is used as intended. In some cases this permissible performance level may be replaced by a permissible loss of performance.
- During the EMC exposure to an electromagnetic phenomenon, a degradation of performance is, however, allowed. No change of the actual mode of operation (e.g. unintended transmission) or stored data is allowed.
- If the minimum performance level or the permissible performance loss is not specified by the manufacturer, then either of these may be deduced from the product description and documentation and what the user may reasonably expect from the equipment if used as intended.

Performance criteria for equipment which does not provide a continuous communication link

For radio equipment which does not provide a continuous communication link, the performance criteria described in clauses 6.1 and 6.2 are not appropriate, in these cases the manufacturer shall declare, for inclusion in the test report, his own specification for an acceptable level of performance or degradation of performance during and/or after the immunity tests. The performance specification shall be included in the product description and documentation. The related specifications set out in clause 5.3 have also to be taken into account.

The performance criteria specified by the manufacturer shall give the same degree of immunity protection as called for in clauses 6.1 and 6.2.

Performance criteria for ancillary equipment tested on a stand-alone basis

If ancillary equipment is intended to be tested on a standalone basis, the performance criteria described in clauses 6.1 and 6.2 are not appropriate, in these cases the manufacturer shall declare, for inclusion in the test report, his own specification for an acceptable level of performance or degradation of performance during and/or after the immunity tests. The performance specification shall be included in the product description and documentation. The related specifications set out in clause 5.3 have also to be taken into account.

The performance criteria specified by the manufacturer shall give the same degree of immunity protection as called for in clauses 6.1 and 6.2.

Special Performance Requirements (ETSI EN 301489-17):

The performance criteria are:

- performance criteria A for immunity tests with phenomena of a continuous nature;
- performance criteria B for immunity tests with phenomena of a transient nature;
- performance criteria C for immunity tests with power interruptions exceeding a certain time.

The equipment shall meet the minimum performance criteria as specified in the following clauses.

Performance criteria for Continuous phenomena applied to Transmitters (CT)

The performance criteria A shall apply.

Tests shall be repeated with the EUT in standby mode (if applicable) to ensure that unintentional transmission does not occur. In systems using acknowledgement signals, it is recognized that an ACKnowledgement (ACK) or Not ACKnowledgement (NACK) transmission may occur, and steps should be taken to ensure that any transmission resulting from the application of the test is correctly interpreted.

Performance criteria for Transient phenomena applied to Transmitters (TT)

The performance criteria B shall apply, except for voltage dips of 100 ms and voltage interruptions of 5000 ms duration, for which performance criteria C shall apply.

Tests shall be repeated with the EUT in standby mode (if applicable) to ensure that unintentional transmission does not occur. In systems using acknowledgement signals, it is recognized that an acknowledgement (ACK) or not-acknowledgement (NACK) transmission may occur, and steps should be taken to ensure that any transmission resulting from the application of the test is correctly interpreted.

Performance criteria for Continuous phenomena applied to Receivers (CR)

The performance criteria A shall apply.

Where the EUT is a transceiver, under no circumstances, shall the transmitter operate unintentionally during the test. In systems using acknowledgement signals, it is recognized that an ACK or NACK transmission may occur, and steps should be taken to ensure that any transmission resulting from the application of the test is correctly interpreted.

Performance criteria for Transient phenomena applied to Receivers (TR)

The performance criteria B shall apply, except for voltage dips of 100 ms and voltage interruptions of 5000 ms duration for which performance criteria C shall apply.

Where the EUT is a transceiver, under no circumstances, shall the transmitter operate unintentionally during the test. In systems using acknowledgement signals, it is recognized that an ACK or NACK transmission may occur, and steps should be taken to ensure that any transmission resulting from the application of the test is correctly interpreted.

EN 301 489 -17 Performance criteria		
Criteria	During Test	After test
A	Shall operate as intended. (see note 1). Shall be no loss of function. Shall be no unintentional transmissions	Shall operate as intended. Shall be no degradation of performance (see note 3). Shall be no loss of function. Shall be no loss of stored data or user programmable functions.
B	May show loss of function (one or more). May show degradation of performance (see note 2). Shall be no unintentional transmissions	Functions shall be self-recoverable. Shall operate as intended after recovering. Shall be no degradation of performance (see note 3). Shall be no loss of stored data or user programmable functions.
C	May be loss of function (one or more)	Functions shall be recoverable by the operator. Shall operate as intended after recovering. Shall be no degradation of performance (see note 3).

Note 1: Operate as intended during the test allows a level of degradation not below a minimum performance level specified by the manufacturer for the use of the apparatus as intended. In some cases the specified minimum performance level may be replaced by a permissible degradation of performance. If the minimum performance level or the permissible performance degradation is not specified by the manufacturer then either of these may be derived from the product description and documentation (including leaflets and advertising) and what the user may reasonably expect from the apparatus if used as intended.

Note 2: Degradation of performance during the test is understood as a degradation to a level not below a minimum performance level specified by the manufacturer for the use of the apparatus as intended. In some cases the specified minimum performance level may be replaced by a permissible degradation of performance.

If the minimum performance level or the permissible performance degradation is not specified by the manufacturer then either of these may be derived from the product description and documentation (including leaflets and advertising) and what the user may reasonably expect from the apparatus if used as intended.

Note 3: No degradation of performance after the test is understood as no degradation below a minimum performance level specified by the manufacturer for the use of the apparatus as intended. In some cases the specified minimum performance level may be replaced by a permissible degradation of performance. After the test no change of actual operating data or user retrievable data is allowed. If the minimum performance level or the permissible performance degradation is not specified by the manufacturer then either of these may be derived from the product description and documentation (including leaflets and advertising) and what the user may reasonably expect from the apparatus if used as intended.

2. Test Configuration of Equipment under Test

2.1. Test Mode

Test Mode	
EMI Mode	Mode 1: Power on and Communication with notebook by Wi-Fi
EMS Mode	Mode 1: Power on and Communication with notebook by Wi-Fi

2.2. Configuration of Tested System

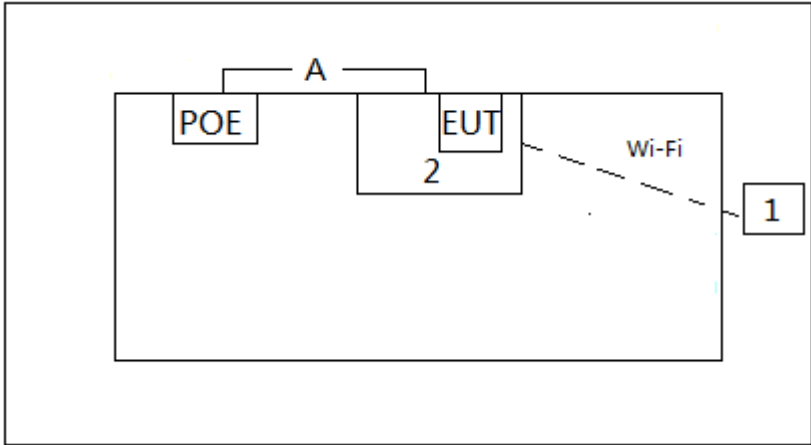
Connection Diagram (Mode 1)	
	
Signal Cable Type	Signal Cable Description
A LAN Cable	Non-Shielded, 0.5m

2.3. Test System Details

The types for all equipments, plus descriptions of all cables used in the tested system (including inserted cards) are:

Product	Manufacturer	Model No.	Serial No.	Power Cord
1 Notebook	Lenovo	E430c	MP-4CFX213/10	Non-Shielded, 1.8m
2 PCB Board	COMPEX	WPJ344	N/A	Non-Shielded, 1.5m

2.4. Test Procedure

1	Setup the EUT and simulators as shown on above.
2	Turn on the power of all equipment.
3	Making EUT communicate with PC by LAN cable and communicate with notebook by Wi-Fi.

3. Test Summary

Test Reference Standard	Test Item	Result (Pass/Fail)	Remark
Emission Measurements			
EN 55032	Radiated Emission	Pass	--
Immunity Measurements			
EN 61000-4-3	Radio-Frequency Electromagnetic Field	Pass	--

4. Radiated Emission

4.1. Limit of Radiated Emission

Frequency range MHz	Quasi-peak limits dB(μ V/m)
30 to 230	40
230 to 1000	47

Note 1: The lower limit shall apply at the transition frequency.

Note 2: Additional provisions may be required for cases where interference occurs.

Frequency range GHz	Average limit dB(μ V/m)	Peak limit dB(μ V/m)
1 to 3	50	70
3 to 6	54	74

Note: The lower limit applies at the transition frequency.

4.2. Test Setup

30 ~ 1000 MHz

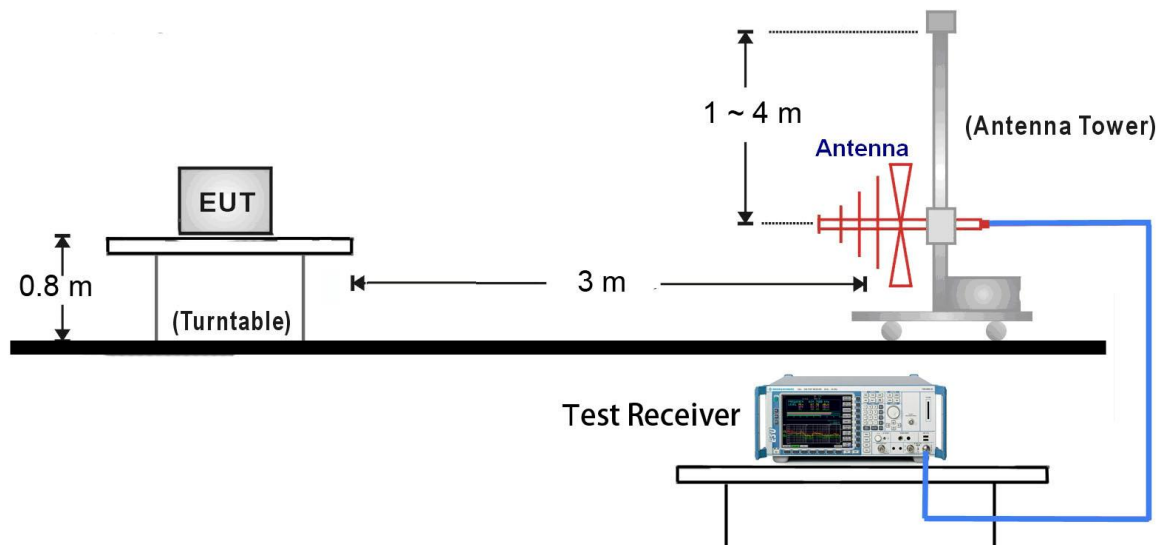

1000 ~ 6000 MHz

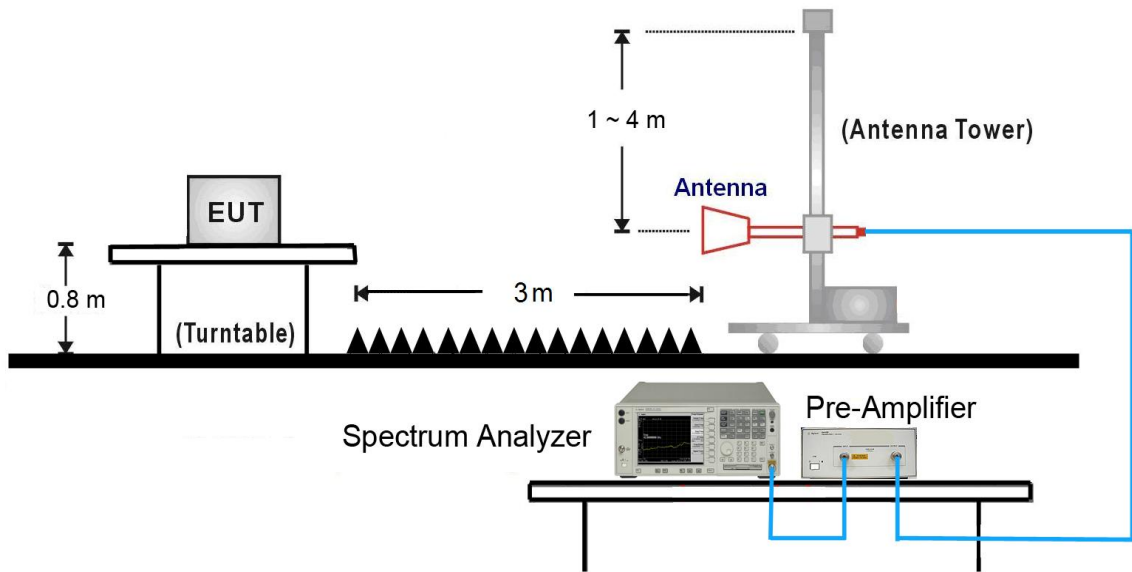

Note: About the radiated test setup, the EUT and local AE shall be arranged in the most compact practical arrangement within the test volume, while respecting typical spacing and the requirements defined in EN55032 Annex D. The central point of the arrangement shall be positioned at the centre of the turntable. The measurement distance is the shortest horizontal distance between an imaginary circular periphery just encompassing this arrangement and the calibration point of the antenna. See below Figure 1 and Figure 2.

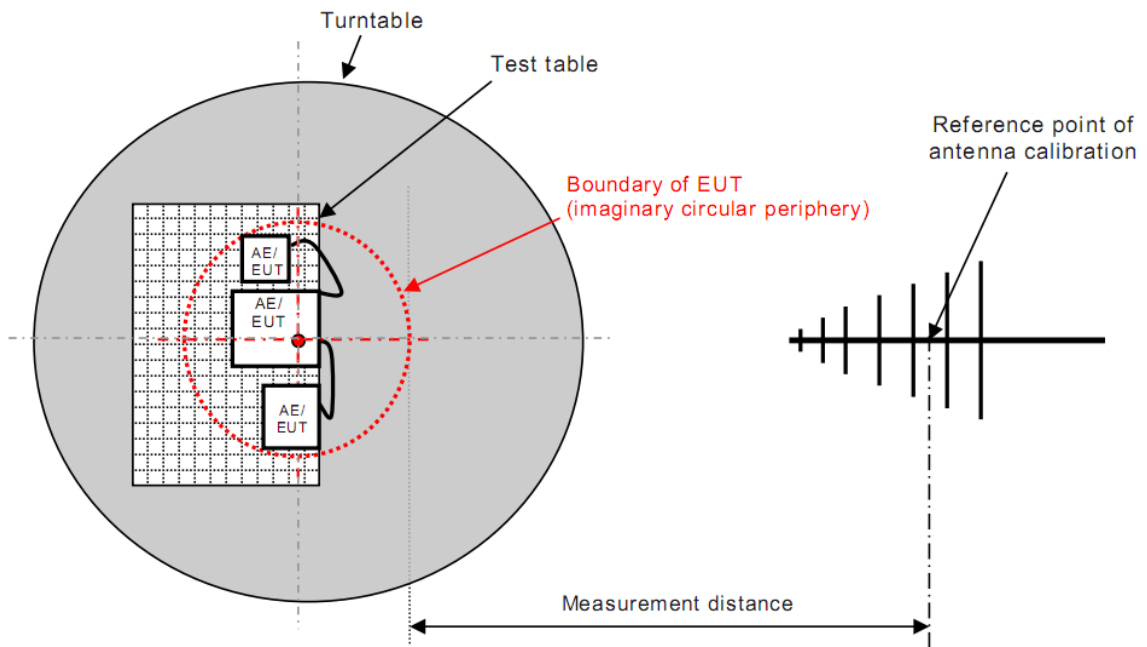

IEC

Figure 1

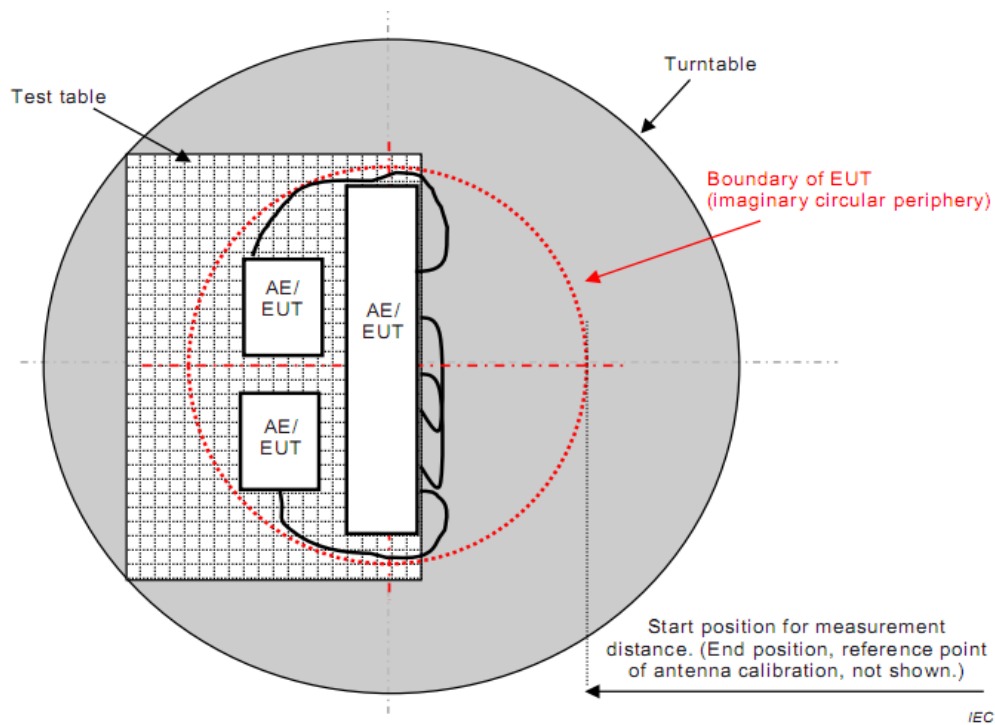

Figure 2

4.3. Test Procedure

Starting with the front of the receiver under test facing the measuring antenna, the measuring antenna is adjusted for horizontal polarization measurement and its height varied between 1 m and 4 m until the maximum reading is obtained.

The receiver under test is then rotated about its centre until the maximum meter reading is obtained, after which the measuring antenna height is again varied between 1 m and 4 m and the maximum reading noted.

The procedure is repeated for vertical polarization of the measuring antenna.

The highest value found, following this procedure, is defined as the radiation figure of the receiver.

If at certain frequencies the ambient signal field strength is high at the position of the receiving antenna, one of the following methods may be used to show compliance of the equipment under test.

- a) For small frequency bands with high ambient signals, the disturbance value may be interpolated from the adjacent values. The interpolated value shall lie on the curve describing a continuous function of the disturbance values adjacent to the ambient noise.
- b) Another possibility is to use the method described in annex C of CISPR 11.

4.4. Test Result

Site: AC1	Time: 2017/07/07 - 03:16
Limit: EN55032_RE(3m)_ClassB	Engineer: Will Yan
Probe: VULB 9168 _20-2000MHz	Polarity: Horizontal
EUT:802.11ac Dual Band Module	Power: AC 230V/50Hz
Test Mode: Mode 1	

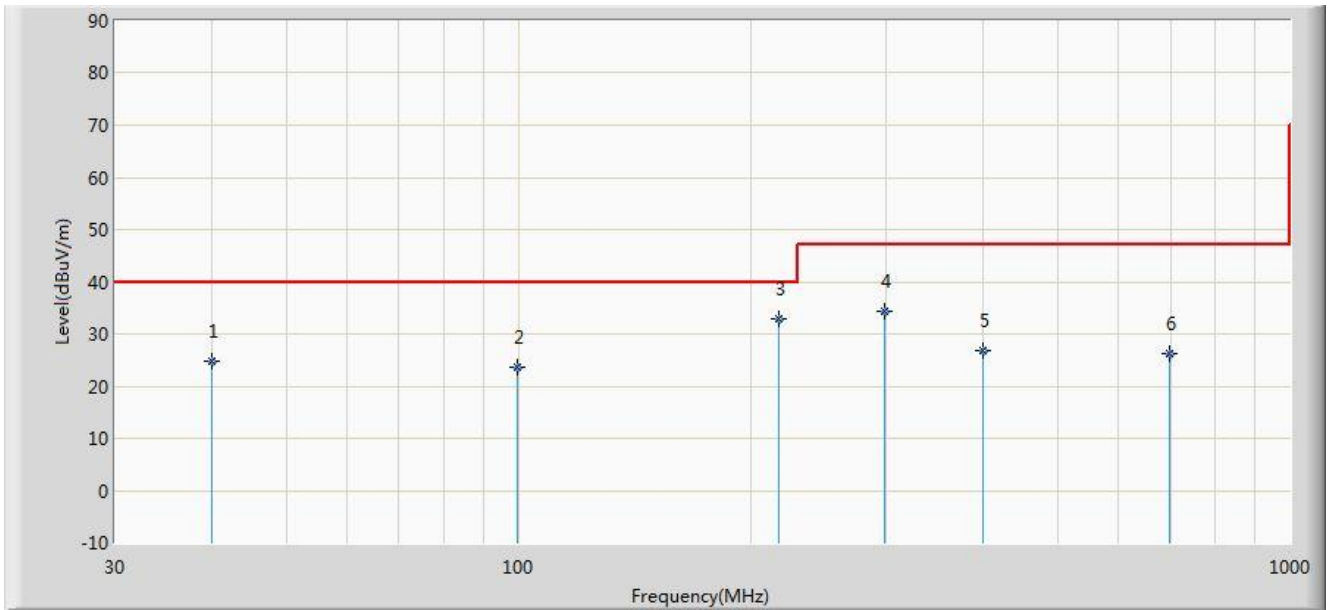

No	Flag	Mark	Frequency (MHz)	Measure Level (dBuV/m)	Reading Level (dBuV)	Over Limit (dB)	Limit (dBuV/m)	Factor (dB)	Type
1			40.055	24.649	10.140	-15.351	40.000	14.509	QP
2			99.840	23.602	12.650	-16.398	40.000	10.952	QP
3			217.145	32.992	21.260	-7.008	40.000	11.732	QP
4		*	298.630	34.409	20.145	-12.591	47.000	14.264	QP
5			400.055	26.742	10.250	-20.258	47.000	16.492	QP
6			699.250	26.217	4.250	-20.783	47.000	21.967	QP

Note: Measure Level (dB μ V/m) = Reading Level (dB μ V) + Factor (dB)

Factor (dB) = Cable Loss (dB) + Antenna Factor (dB/m).

Site: AC1	Time: 2017/07/07 - 03:16
Limit: EN55032_RE(3m)_ClassB	Engineer: Will Yan
Probe: VULB 9168 _20-2000MHz	Polarity: Vertical
EUT:802.11ac Dual Band Module	Power: AC 230V/50Hz
Test Mode: Mode 1	

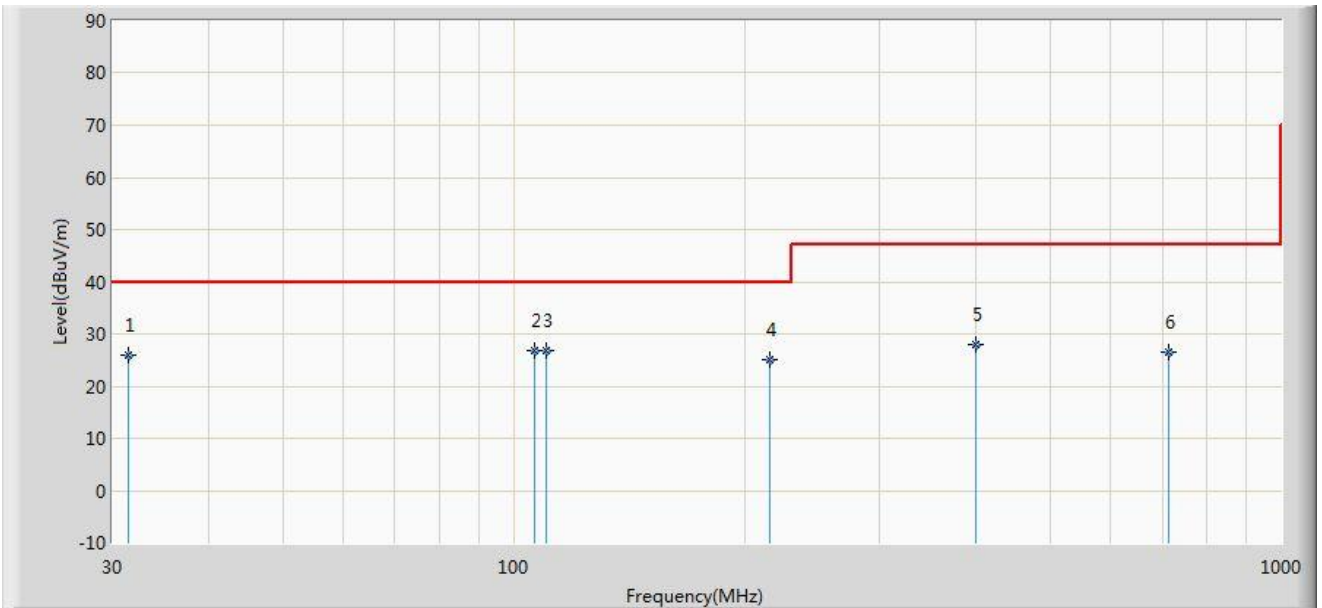

No	Flag	Mark	Frequency (MHz)	Measure Level (dBuV/m)	Reading Level (dBuV)	Over Limit (dB)	Limit (dBuV/m)	Factor (dB)	Type
1			31.455	25.810	12.140	-14.190	40.000	13.670	QP
2		*	106.630	26.869	15.225	-13.131	40.000	11.644	QP
3			110.510	26.688	14.630	-13.312	40.000	12.058	QP
4			215.755	25.099	13.450	-14.901	40.000	11.649	QP
5			400.055	27.942	11.450	-19.058	47.000	16.492	QP
6			712.630	26.431	4.250	-20.569	47.000	22.181	QP

Note: Measure Level (dB μ V/m) = Reading Level (dB μ V) + Factor (dB)

Factor (dB) = Cable Loss (dB) + Antenna Factor (dB/m).

Site: AC1	Time: 2017/07/07 - 03:16
Limit: EN55032_RE(3m)_ClassB	Engineer: Will Yan
Probe: BBHA9120D_1-18GHz	Polarity: Horizontal
EUT:802.11ac Dual Band Module	Power: AC 230V/50Hz
Test Mode: Mode 1	

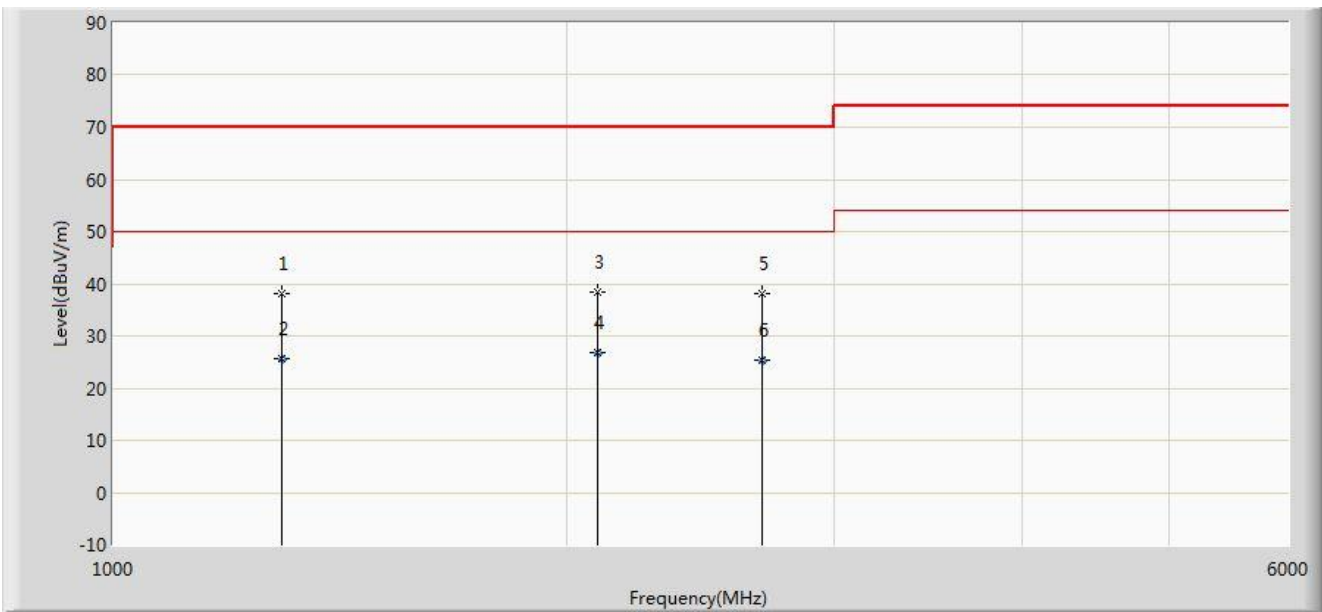

No	Flag	Mark	Frequency (MHz)	Measure Level (dBuV/m)	Reading Level (dBuV)	Over Limit (dB)	Limit (dBuV/m)	Factor (dB)	Type
1			1295.000	38.063	46.341	-31.937	70.000	-8.277	PK
2			1295.140	25.743	34.020	-24.257	50.000	-8.277	AV
3			2095.000	38.353	43.125	-31.647	70.000	-4.773	PK
4			2095.140	26.679	31.450	-23.321	50.000	-4.770	AV
5			2692.500	38.114	40.911	-31.886	70.000	-2.797	PK
6		*	2692.650	25.234	28.030	-24.766	50.000	-2.795	AV

Note: Measure Level (dB μ V/m) = Reading Level (dB μ V) + Factor (dB)

Factor (dB) = Cable Loss (dB) + Antenna Factor (dB/m) - Pre_Amplifier Gain (dB).

Site: AC1	Time: 2017/07/07 - 03:16
Limit: EN55032_RE(3m)_ClassB	Engineer: Will Yan
Probe: BBHA9120D_1-18GHz	Polarity: Vertical
EUT:802.11ac Dual Band Module	Power: AC 230V/50Hz
Test Mode: Mode 1	

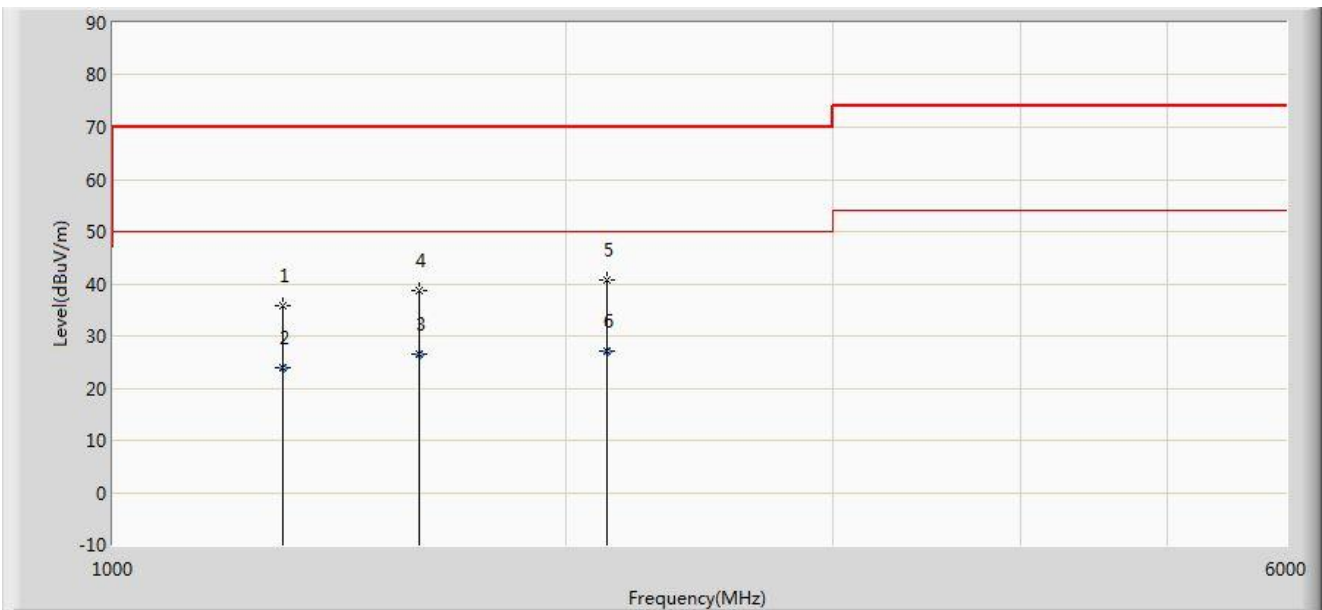

No	Flag	Mark	Frequency (MHz)	Measure Level (dBuV/m)	Reading Level (dBuV)	Over Limit (dB)	Limit (dBuV/m)	Factor (dB)	Type
1			1297.500	35.821	44.083	-34.179	70.000	-8.262	PK
2			1297.550	23.858	32.120	-26.142	50.000	-8.262	AV
3			1597.050	26.540	34.230	-23.460	50.000	-7.690	AV
4		*	1597.500	38.684	46.374	-31.316	70.000	-7.689	PK
5			2125.000	40.804	45.236	-29.196	70.000	-4.432	PK
6			2125.210	27.040	31.470	-22.960	50.000	-4.430	AV

Note: Measure Level (dB μ V/m) = Reading Level (dB μ V) + Factor (dB)

Factor (dB) = Cable Loss (dB) + Antenna Factor (dB/m) - Pre_Amplifier Gain (dB).

4.5. Test Photograph

Test Mode: Mode 1

Description: Radiated Emission Test Setup (30MHz ~ 1GHz)

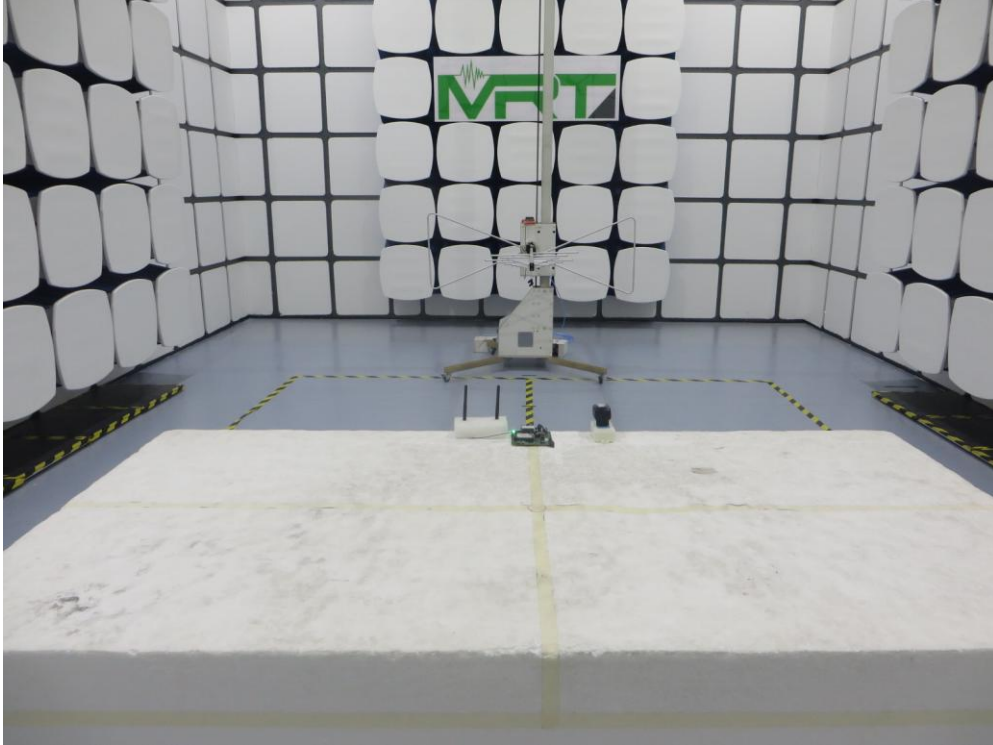

Test Mode: Mode 1

Description: Radiated Emission Test Setup (1 ~ 6GHz)

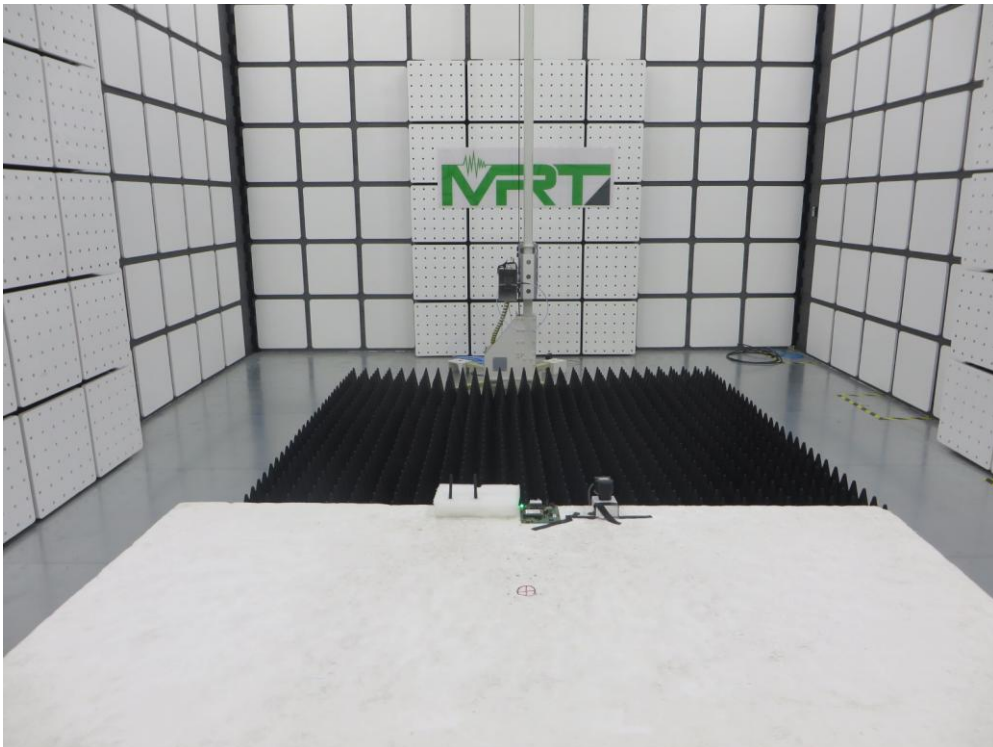

5. Radio-Frequency Electromagnetic Field

5.1. Limit of Radio-Frequency Electromagnetic Field

Environmental phenomenon	Test specification	Units	Performance criterion
Enclosure port			
Radio frequency electromagnetic field	80 - 6000	MHz	A
	3	V/m (unmodulated, r.m.s)	
	80	% AM (1kHz)	

Note 1: If the wanted signal is modulated at 1000Hz, then an audio signal of 400Hz shall be used.

Note 2: The test shall be performed over the frequency range 80MHz to 6000MHz with the exception of the exclusion band for transmitters, receivers and duplex transceivers of EN 301 489-1, as appropriate.

5.2. Test Setup

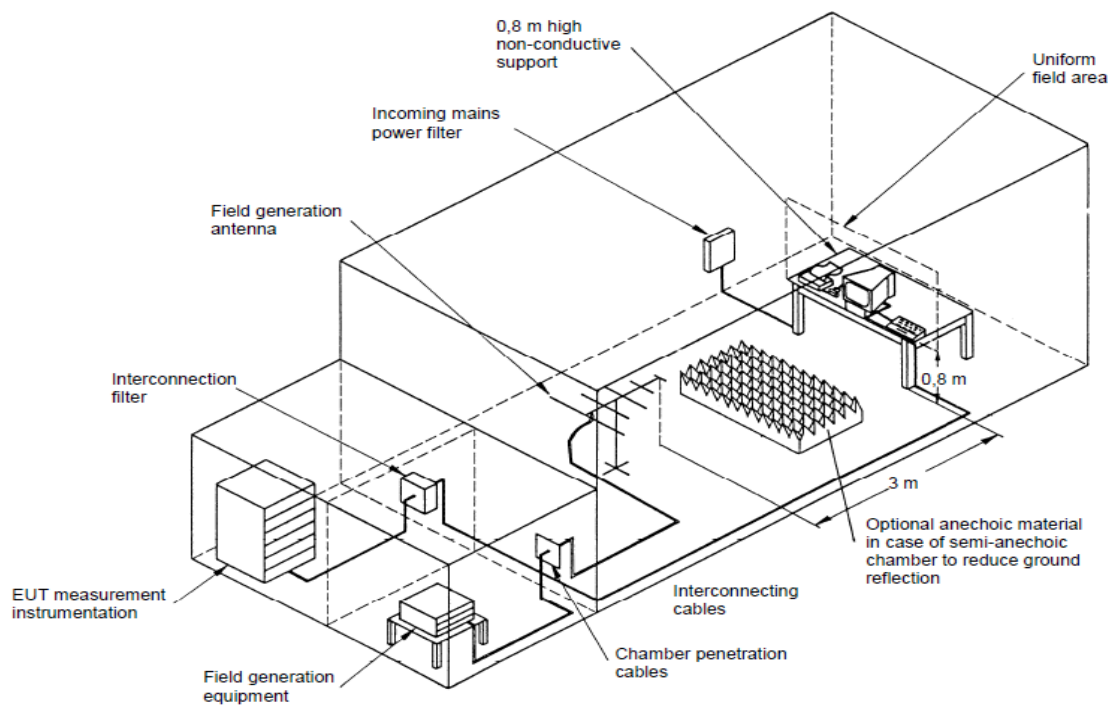

5.3. Test Procedure

The EUT and load, which are placed on a table that is 0.8 meter above ground, are placed with one coincident with the calibration plane such that the distance from antenna to the EUT was 3 meters. Both horizontal and vertical polarization of the antenna and four sides of the EUT are set on measurement.

All the scanning conditions are as follows:

	Condition of Test	Remarks
1.	Field Strength	3V/m
2.	Radiated Signal	AM 80% Modulated with 1kHz
3.	Scanning Frequency	80MHz - 6GHz
4.	Dwell Time	3 Seconds
5.	Frequency Step Size Δf	1%

5.4. Test Result

EUT	802.11ac Dual Band Module	Temperature	25°C
Test Engineer	Jone Zhang	Relative Humidity	52%
Test Mode	Mode 1	Date of Test	2017/07/04

Frequency (MHz)	Polarity	Test Position	Field Strength (V/m)	Test Result
80 - 6000	Horizontal/Vertical	Front	3	Pass
		Rear		Pass
		Left		Pass
		Right		Pass
		Top		Pass
		Bottom		Pass

Note: The EUT performance complied with performance criteria for CT & CR to MS Function and there is no any degradation of performance and function, and performance criterion was A.

5.5. Test Photograph

Test Mode: Mode 1

Description: Radio-frequency Electromagnetic Field Test Setup



6. Uncertainty Measurement

Radiated Disturbance - AC1

The maximum measurement uncertainty is evaluated as:

Horizontal: 30MHz~300MHz: ± 4.07 dB

300MHz~1GHz: ± 3.63 dB

Vertical: 30MHz~300MHz: ± 4.18 dB

300MHz~1GHz: ± 3.60 dB

Radiated Disturbance - AC2

The maximum measurement uncertainty is evaluated as:

Horizontal: 1GHz~6GHz: ± 4.16 dB

Vertical: 1GHz~6GHz: ± 4.76 dB

7. List of Measuring Instrument

Radiated Disturbance - AC1

Instrument	Manufacturer	Type No.	Asset No.	Cali. Interval	Cali. Due Date
MXE EMI Receiver	Agilent	N9038A	MRTSUE06125	1 year	2017/08/19
Microwave System Amplifier	Agilent	83017A	MRTSUE06076	1 year	2018/03/27
Bilog Period Antenna	Schwarzbeck	VULB 9168	MRTSUE06172	1 year	2017/11/19
Horn Antenna	Schwarzbeck	BBHA9120D	MRTSUE06023	1 year	2017/10/22
Temperature/Humidity Meter	Yuhuaze	HTC-2	MRTSUE06183	1 year	2017/12/22
Anechoic Chamber	TDK	Chamber-AC1	MRTSUE06212	1 year	2018/05/10

Radiated Disturbance - AC2

Instrument	Manufacturer	Type No.	Asset No.	Cali. Interval	Cali. Due Date
MXE EMI Receiver	Agilent	N9038A	MRTSUE06125	1 year	2017/08/19
Broadband Coaxial Pre-amplifier	Schwarzbeck	BBV 9718	MRTSUE06176	1 year	2017/11/06
Bilog Period Antenna	Schwarzbeck	VULB 9162	MRTSUE06022	1 year	2017/11/06
Horn Antenna	Schwarzbeck	BBHA9120D	MRTSUE06171	1 year	2017/12/10
Digital Thermometer & Hygrometer	Minggao	ETH529	MRTSUE06170	1 year	2017/11/29
Anechoic Chamber	RIKEN	Chamber-AC2	MRTSUE06213	1 year	2018/05/10

Radio-Frequency Electromagnetic Field - AC2

Instrument	Manufacturer	Type No.	Asset No.	Cali. Interval	Cali. Due Date
Signal Generator	Agilent	E4438C	MRTSUE06081	1 year	2017/12/06
EPM Series Power Meter	Agilent	E4418B	MRTSUE06204	1 year	2018/06/26
Power Sensor	Agilent	E9301H	MRTSUE06205	1 year	2018/06/26
Power Amplifier	AR	150W1000M1	MRTSUE06146	N/A	N/A
Power Amplifier	rflight	NTWPAS-1025 100	MRTSUE06264	1 year	2018/04/12
Power Amplifier	rflight	NTWPAS-2560 100	MRTSUE06263	1 year	2018/04/12
High-Gain Horn Antenna	AR	ATH800M5GA	MRTSUE06144	N/A	N/A
Log-Periodic Antenna	AR	ATR80M6G	MRTSUE06145	N/A	N/A
Digital Thermometer & Hygrometer	Minggao	ETH529	MRTSUE06170	1 year	2017/11/29
Anechoic Chamber	RIKEN	Chamber-AC2	MRTSUE06213	1 year	2018/05/10

Software	Version	Function
e3	v 8.3.5	EMI Test Software
JS32-RS	v 1.0.0.1	RS Test Software

————— The End —————

8. Appendix - Original Report



MEASUREMENT REPORT

EN 301 489-1 & EN 301 489-17

Applicant: Compex Systems Pte Ltd

Address: No:9 Harrison Road, Harrison Industrial Building, #05-01,
Singapore 369651

Product: 802.11ac Dual Band Module

Model No.: WLE600VX, WLE600VX-I

Brand Name: COMPEX

Standards: ETSI EN 301 489 - 1 V1.9.2 (2011-09)
ETSI EN 301 489 - 17 V2.2.1 (2012-09)

Result: Complies

Test Date: Mar. 16 ~ Jun. 15, 2015

Reviewed By : Robin Wu
(Robin Wu)

Approved By : Marlin Chen
(Marlin Chen)



The test results relate only to the samples tested.

The test results shown in the test report are traceable to the national/international standards through the calibration of the equipment and evaluated measurement uncertainty herein.

The test report shall not be reproduced except in full without the written approval of MRT Technology (Suzhou) Co., Ltd.

Revision History

Report No.	Version	Description	Issue Date
1503RSU02910	Rev. 01	Initial report	06-15-2015
1503RSU02910	Rev. 02	Update some test descriptions	06-24-2015
1503RSU02910	Rev. 03	Revised the applicant's address	03-03-2017

CONTENTS

Description	Page
1. General Information.....	6
1.1. Applicant.....	6
1.2. Manufacturer	6
1.3. Testing Facility	6
1.4. Feature of Product	7
1.5. Standards Applicable for Testing	8
1.6. Performance Criteria.....	9
2. Test Configuration of Equipment under Test	15
2.1. Test Mode.....	15
2.2. Configuration of Tested System	15
2.3. Test System Details	16
2.4. Test Software.....	16
3. Test Summary	17
4. Conducted Emission	18
4.1. Limit of Conducted Emission	18
4.2. Test Setup	18
4.3. Test Procedure	19
4.4. Test Result.....	20
4.5. Test Photograph	22
5. Radiated Emission.....	23
5.1. Limit of Radiated Emission	23
5.2. Test Setup	23
5.3. Test Procedure	25
5.4. Test Result.....	26
5.5. Test Photograph	30
6. Harmonic Current Emissions.....	31
6.1. Limit of Harmonic Current Emissions	31
6.2. Test Setup	31
6.3. Test Procedure	31
6.4. Test Result.....	32
6.5. Test Photograph	34
7. Voltage Fluctuations and Flicker	35

7.1.	Limit of Voltage Fluctuations and Flicker	35
7.2.	Test Setup	36
7.3.	Test Procedure	36
7.4.	Test Result.....	37
7.5.	Test Photograph	38
8.	Electrostatic Discharge	39
8.1.	Limit of Electrostatic Discharge.....	39
8.2.	Test Setup	39
8.3.	Test Procedure	40
8.4.	Test Result.....	41
8.5.	Test Photograph	42
9.	Radio-frequency Electromagnetic Field.....	43
9.1.	Limit of Radio-frequency Electromagnetic Field.....	43
9.2.	Test Setup	43
9.3.	Test Procedure	44
9.4.	Test Result.....	45
9.5.	Test Photograph	46
10.	Electrical Fast Transients	47
10.1.	Limit of Electrical Fast Transients	47
10.2.	Test Setup	47
10.3.	Test Procedure	47
10.4.	Test Result.....	49
10.5.	Test Photograph	50
11.	Surges	51
11.1.	Limit of Surges.....	51
11.2.	Test Setup	51
11.3.	Test Procedure	52
11.4.	Test Result.....	53
11.5.	Test Photograph	54
12.	Radio-frequency Common Mode	55
12.1.	Limit of Radio-frequency Common Mode.....	55
12.2.	Test Setup	55
12.3.	Test Procedure	55
12.4.	Test Result.....	57
12.5.	Test Photograph	58

13. Voltage Dips and Interruptions	59
13.1. Limit of Voltage Dips and Interruptions.....	59
13.2. Test Setup	59
13.3. Test Procedure	59
13.4. Test Result.....	60
13.5. Test Photograph	61
14. Uncertainty Measurement	62
15. List of Measuring Instrument.....	63
16. Appendix - EUT Photograph	66

1. General Information

1.1. Applicant

Compex Systems Pte Ltd

No:9 Harrison Road, Harrison Industrial Building, #05-01, Singapore 369651

1.2. Manufacturer

Compex Systems Pte Ltd

No:9 Harrison Road, Harrison Industrial Building, #05-01, Singapore 369651

1.3. Testing Facility

Test Site

MRT Technology (Suzhou) Co., Ltd

Test Site Location

D8 Building, No.2 Tian'edang Rd., Wuzhong Economic Development Zone, Suzhou, China

Radio-frequency Electromagnetic Field Test Site

Quietek Technology (Suzhou) Co., Ltd.

Test Site Location

No.99 Hongye Rd., Suzhou Industrial Park Loufeng Hi-Tech Development Zone., Suzhou, China

Test Facility / Accreditations

Measurements were performed at MRT Laboratory located in Tian'edang Rd., Suzhou, China.

- MRT facility is a FCC registered (MRT Reg. No. 809388) test facility with the site description report on file and has met all the requirements specified in Section 2.948 of the FCC Rules.
- MRT facility is an IC registered (MRT Reg. No. 11384A-1) test laboratory with the site description on file at Industry Canada.
- MRT facility is a VCCI registered (R-4179, G-814, C-4664, T-2206) test laboratory with the site description on file at VCCI Council.
- MRT Lab is accredited to ISO 17025 by the American Association for Laboratory Accreditation (A2LA) under the American Association for Laboratory Accreditation Program (A2LA Cert. No. 3628.01) in EMC, Telecommunications and Radio testing for FCC, Industry Canada, EU and TELEC Rules.



1.4. Feature of Product

Product Name	802.11ac Dual Band Module
Model No.	WLE600VX, WLE600VX-I
Brand Name	COMPEX
Frequency Range	<u>For 2.4GHz Band:</u> 802.11b/g/n: 2412 ~ 2472 MHz <u>For 5GHz Band:</u> 802.11a/n/ac: 5150 ~ 5350MHz 5470 ~ 5825MHz
Type of Modulation	802.11b: DSSS 802.11g/a/n/ac: OFDM
Data Rate	802.11a: 6/9/12/18/24/36/48/54Mbps 802.11n: up to 300Mbps 802.11ac: up to 866.6Mbps

1.5. Standards Applicable for Testing

The EUT complies with the requirements of EN 3014 89-1 V1.9.2 & EN 301 489-17 V2.2.1.

EMI Test:

EN 55022 2010/AC: 2011 (Conducted Emission)

EN 55022 2010/AC: 2011 (Radiated Emission)

EN 61000-3-2: 2009 (Harmonic)

EN 61000-3-3: 2008 (Flicker)

EMS Test:

EN 61000-4-2: 2009 (ESD)

EN 61000-4-3: 2006+A1:2008+A2:2010 (RS)

EN 61000-4-4: 2004+A1:2010 (EFT)

EN 61000-4-5: 2006 (Surge)

EN 61000-4-6: 2009 (CS)

EN 61000-4-11: 2004 (Dips)

1.6. Performance Criteria

General Requirements (ETSI EN 301489-1):

The performance criteria are used to take a decision on whether radio equipment passes or fails immunity tests.

For the purpose of the present document four categories of performance criteria apply:

- performance criteria for continuous phenomena applied to transmitters;
- performance criteria for transient phenomena applied to transmitters;
- performance criteria for continuous phenomena applied to receivers;
- performance criteria for transient phenomena applied to receivers.

Normally, the performance criteria depend on the type of radio equipment. Thus, the present document only contains general performance criteria commonly used for the assessment of radio equipment. More specific and product-related performance criteria for a dedicated type of radio equipment may be found in the part of EN 301 489 series dealing with the particular type of radio equipment.

Performance criteria for continuous phenomena applied to transmitters and receivers

If no further details are given in the relevant part of EN 301 489 series dealing with the particular type of radio equipment, the following general performance criteria for continuous phenomena shall apply.

During and after the test, the apparatus shall continue to operate as intended. No degradation of performance or loss of function is allowed a permissible performance level specified by the manufacturer when the apparatus is used as intended. In some cases this permissible performance level may be replaced by a permissible loss of performance.

During the test the EUT shall not unintentionally transmit or change its actual operating state and stored data.

If the minimum performance level or the permissible performance loss is not specified by the manufacturer, then either of these may be deduced from the product description and documentation and what the user may reasonably expect from the apparatus if used as intended.

Performance criteria for transient phenomena applied to transmitters and receivers

If no further details are given in the relevant part of EN 301 489 series dealing with the particular type of radio equipment, the following general performance criteria for transient phenomena shall apply.

After the test, the apparatus shall continue to operate as intended. No degradation of performance or loss of function is allowed below a permissible performance level specified by the manufacturer, when the apparatus is used as intended. In some cases this permissible performance level may be replaced by a permissible loss of performance.

During the EMC exposure to an electromagnetic phenomenon, a degradation of performance is, however, allowed. No change of the actual mode of operation (e.g. unintended transmission) or stored data is allowed.

If the minimum performance level or the permissible performance loss is not specified by the manufacturer, then either of these may be deduced from the product description and documentation and what the user may reasonably expect from the apparatus if used as intended.

Performance criteria for equipment which does not provide a continuous communication link

For radio equipment which does not provide a continuous communication link, the performance criteria described in clauses (1) and (2) are not appropriate, then the manufacturer shall declare, for inclusion in the test report, his own specification for an acceptable level of performance or degradation of performance during and/or after the immunity tests. The performance specification shall be included in the product description and documentation. The related specifications set out in clause 5.3 of EN 301 489-1 V1.9.2 (2010-09) have also to be taken into account.

The performance criteria specified by the manufacturer shall give the same degree of immunity protection as called for in clauses (1) and (2).

Performance criteria for ancillary equipment tested on a stand-alone basis

If ancillary equipment is intended to be tested on a stand-alone basis, the performance criteria described in clauses (1) and (2) are not appropriate, then the manufacturer shall declare, for inclusion in the test report, his own specification for an acceptable level of performance or degradation of performance during and/or after the immunity tests. The performance specification shall be included in the product description and documentation. The related specifications set out in clause 5.3 of EN 301 489-1 V1.9.2 (2010-09) have also to be taken into account.

The performance criteria specified by the manufacturer shall give the same degree of immunity protection as called for in clauses (1) and (2).

Special Performance Requirements (ETSI EN 301489-17):

The performance criteria are:

- performance criteria A for immunity tests with phenomena of a continuous nature;
- performance criteria B for immunity tests with phenomena of a transient nature;
- performance criteria C for immunity tests with power interruptions exceeding a certain time.

The equipment shall meet the minimum performance criteria as specified in the following clauses.

Performance criteria for Continuous phenomena applied to Transmitters (CT)

The performance criteria A shall apply.

Tests shall be repeated with the EUT in standby mode (if applicable) to ensure that unintentional transmission does not occur. In systems using acknowledgement signals, it is recognized that an ACKnowledgement (ACK) or Not ACKnowledgement (NACK) transmission may occur, and steps should be taken to ensure that any transmission resulting from the application of the test is correctly interpreted.

Performance criteria for Transient phenomena applied to Transmitters (TT)

The performance criteria B shall apply, except for voltage dips of 100 ms and voltage interruptions of 5000 ms duration, for which performance criteria C shall apply.

Tests shall be repeated with the EUT in standby mode (if applicable) to ensure that unintentional transmission does not occur. In systems using acknowledgement signals, it is recognized that an acknowledgement (ACK) or not-acknowledgement (NACK) transmission may occur, and steps should be taken to ensure that any transmission resulting from the application of the test is correctly interpreted.

Performance criteria for Continuous phenomena applied to Receivers (CR)

The performance criteria A shall apply.

Where the EUT is a transceiver, under no circumstances, shall the transmitter operate unintentionally during the test. In systems using acknowledgement signals, it is recognized that an ACK or NACK transmission may occur, and steps should be taken to ensure that any transmission resulting from the application of the test is correctly interpreted.

Performance criteria for Transient phenomena applied to Receivers (TR)

The performance criteria B shall apply, except for voltage dips of 100 ms and voltage interruptions of 5000 ms duration for which performance criteria C shall apply.

Where the EUT is a transceiver, under no circumstances, shall the transmitter operate unintentionally during the test. In systems using acknowledgement signals, it is recognized that an ACK or NACK transmission may occur, and steps should be taken to ensure that any transmission resulting from the application of the test is correctly interpreted.

EN 301 489 -17 Performance criteria		
Criteria	During Test	After test
A	Shall operate as intended May show degradation of performance (see note 1) Shall be no loss of function Shall be no unintentional transmissions	Shall operate as intended Shall be no degradation of performance (see note 2) Shall be no loss of function Shall be no loss of stored data or user programmable functions
B	May show loss of function (one or more) May show degradation of performance (see note 1) No unintentional transmission	Functions shall be self-recoverable Shall operate as intended after recovering Shall be no degradation of performance (see note 2) Shall be no loss of stored data or user programmable functions
C	May be loss of function (one or more)	Functions shall be recoverable by the operator Shall operate as intended after recovering Shall be no degradation of performance (see note 2)

Note 1: Degradation of performance during the test is understood as a degradation to a level not below a minimum performance level specified by the manufacturer for the use of the apparatus as intended. In some cases the specified minimum performance level may be replaced by a permissible degradation of performance.

If the minimum performance level or the permissible performance degradation is not specified by the manufacturer then either of these may be derived from the product description and documentation (including leaflets and advertising) and what the user may reasonably expect from the apparatus if used as intended.

Note 2: No degradation of performance after the test is understood as no degradation below a minimum performance level specified by the manufacturer for the use of the apparatus as intended. In some cases the specified minimum performance level may be replaced by a permissible degradation of performance. After the test no change of actual operating data or user retrievable data is allowed. If the minimum performance level or the permissible performance degradation is not specified by the manufacturer then either of these may be derived from the product description and documentation (including leaflets and advertising) and what the user may reasonably expect from the apparatus if used as intended.

2. Test Configuration of Equipment under Test

2.1. Test Mode

EMI Test Mode	Mode 1: Power on and Communication with notebook by Wi-Fi
EMS Test Mode	Mode 1: Power on and Communication with notebook by Wi-Fi

Note: In the process of communication, the EUT can transmit and receive with notebook by Wi-Fi technology.

2.2. Configuration of Tested System

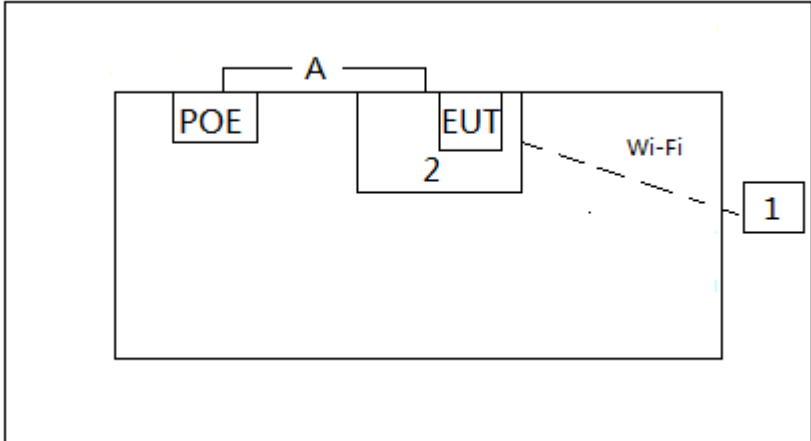
Connection Diagram		
 <p>The diagram shows a POE (Power over Ethernet) source connected to an EUT (Equipment Under Test) via a cable labeled 'A'. The EUT is connected to a notebook (labeled '1') via Wi-Fi. The notebook is also labeled '1' in a box.</p>		
Signal Cable Type	Signal Cable Description	
A	LAN Cable	Non-shielding, 0.5m

2.3. Test System Details

The types for all equipments, plus descriptions of all cables used in the tested system (including inserted cards) are:

Product	Manufacturer	Model No.	Serial No.	Power Cord	
1	Notebook	Lenovo	E430c	MP-4CFX213/10	Non-Shielded, 1.8m
2	PCB Board	COMPEX	WPJ344	N/A	Non-Shielded, 1.5m

2.4. Test Software

1	Setup the EUT and simulators as shown on above.
2	Turn on the power of all equipment.
3	Making EUT communicate with PC by LAN cable and communicate with notebook by Wi-Fi.

3. Test Summary

Clause	Test Item	Test Standard	Result (Pass/Fail)	Remark
Emission Measurements				
EN 301489-1 Clause 8.4	Conducted Emission	EN 55022	Pass	---
EN 301489-1 Clause 8.2	Radiated Emission	EN 55022	Pass	---
EN 301489-1 Clause 8.5	Harmonic Current Emissions	EN 61000-3-2	Pass	---
EN 301489-1 Clause 8.6	Voltage Fluctuations and Flicker	EN 61000-3-3	Pass	---
Immunity Measurements				
EN 301489-1 Clause 9.3	Electrostatic Discharge	EN 61000-4-2	Pass	---
EN 301489-1 Clause 9.2	Radio-frequency Electromagnetic Field	EN 61000-4-3	Pass	---
EN 301489-1 Clause 9.4	Fast transients, Common Mode	EN 61000-4-4	Pass	---
EN 301489-1 Clause 9.8	Surges	EN 61000-4-5	Pass	---
EN 301489-1 Clause 9.5	Radio-frequency Common Mode	EN 61000-4-6	Pass	---
EN 301489-1 Clause 9.6	Transients and Surge	ISO 7637-2	N/A	Only for vehicular product
EN 301489-1 Clause 9.7	Voltage Dips and Interruptions	EN 61000-4-11	Pass	---

4. Conducted Emission

4.1. Limit of Conducted Emission

Limits of conducted emission for AC mains power input/output ports				
Frequency range MHz	Limits dB(μ V)			
	Quasi-peak		Average	
0.15 to 0.50	66 to 56		56 to 46	
0.50 to 5	56		46	
5 to 30	60		50	
Limits of conducted emission for telecommunication ports				
Frequency range MHz	Voltage Limits dB(μ V)		Current limits dB(μ A)	
	Quasi-peak	Average	Quasi-peak	Average
0.15 to 0.50	84 to 74	74 to 64	40 to 30	30 to 20
0.50 to 30	74	64	30	20

4.2. Test Setup

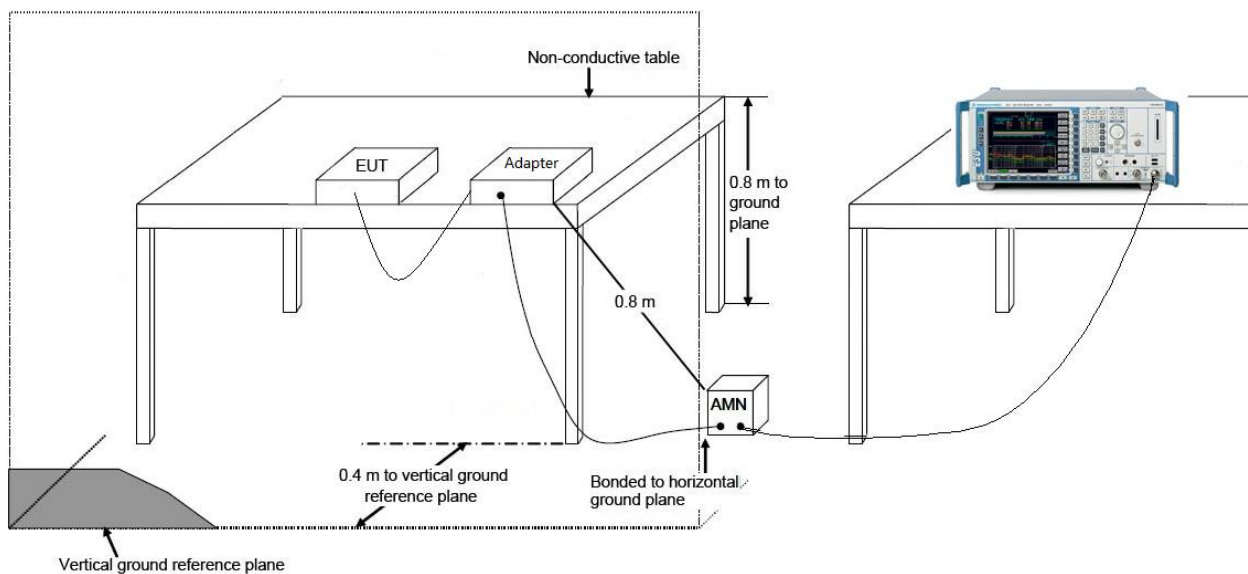

4.3. Test Procedure

The receiver or associated equipment under measurement and the artificial mains network are disposed as shown in 3.2. Measurements shall be carried out using a selective voltmeter having a quasi-peak detector for broadband measurements and an average detector for narrow-band measurements in accordance with CISPR 16-1.

The mains lead shall be arranged to follow the shortest possible path between the receiver and artificial mains network on the ground. The mains lead in excess of 0,8 m separating the equipment under test from the artificial mains network shall be folded back and forth parallel to the lead so as to form a bundle with a length of 0,3 m to 0,4 m.

Earthing of the equipment under test if provided with a safety earth connection, shall be made to the earth terminal provided on the artificial mains network with the shortest possible lead.

If the equipment under test has a coaxial RF input connector, tests shall be performed with and without an earth connection made to the outer conductor screen of the coaxial RF input connector. When these tests are being carried out, no other earth connections shall be made to any additional earth terminal whatever.

If the equipment under test has no coaxial RF input connector and if it has an earth terminal, tests shall be performed with this terminal earthed.

4.4. Test Result

Site: SR2	Time: 2015/06/12 - 19:34
Limit: EN55022_CE_Mains_ClassB	Engineer: Milo Li
Probe: ENV216_101683_Filter On	Polarity: Line
EUT: 802.11ac Dual Band Module	Power: AC 230V/50Hz
Note: Mode 1	

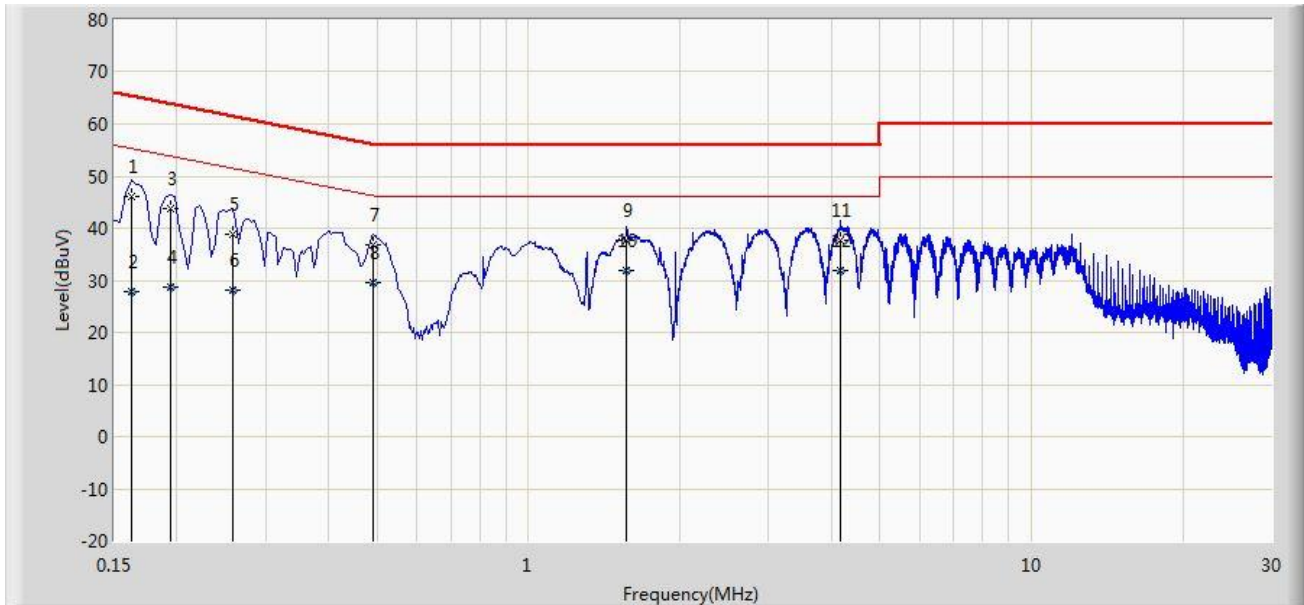

No	Flag	Mark	Frequency (MHz)	Measure Level (dBuV)	Reading Level (dBuV)	Over Limit (dB)	Limit (dBuV)	Factor (dB)	Type
1			0.162	45.974	35.877	-19.387	65.361	10.097	QP
2			0.162	27.969	17.872	-27.392	55.361	10.097	AV
3			0.194	43.691	33.674	-20.172	63.864	10.017	QP
4			0.194	28.762	18.745	-25.102	53.864	10.017	AV
5			0.258	38.825	28.854	-22.671	61.496	9.970	QP
6			0.258	28.101	18.131	-23.394	51.496	9.970	AV
7			0.490	36.948	26.790	-19.219	56.168	10.158	QP
8			0.490	29.428	19.270	-16.739	46.168	10.158	AV
9			1.566	37.760	27.874	-18.240	56.000	9.886	QP
10		*	1.566	31.908	22.022	-14.092	46.000	9.886	AV
11			4.178	37.702	27.727	-18.298	56.000	9.975	QP
12			4.178	31.834	21.859	-14.166	46.000	9.975	AV

Note: Measure Level (dBμV) = Reading Level (dBμV) + Factor (dB)

Factor (dB) = Cable Loss (dB) + LISN Factor (dB).

Site: SR2	Time: 2015/06/12 - 19:40
Limit: EN55022_CE_Mains_ClassB	Engineer: Milo Li
Probe: ENV216_101683_Filter On	Polarity: Neutral
EUT: 802.11ac Dual Band Module	Power: AC 230V/50Hz
Note: Mode 1	

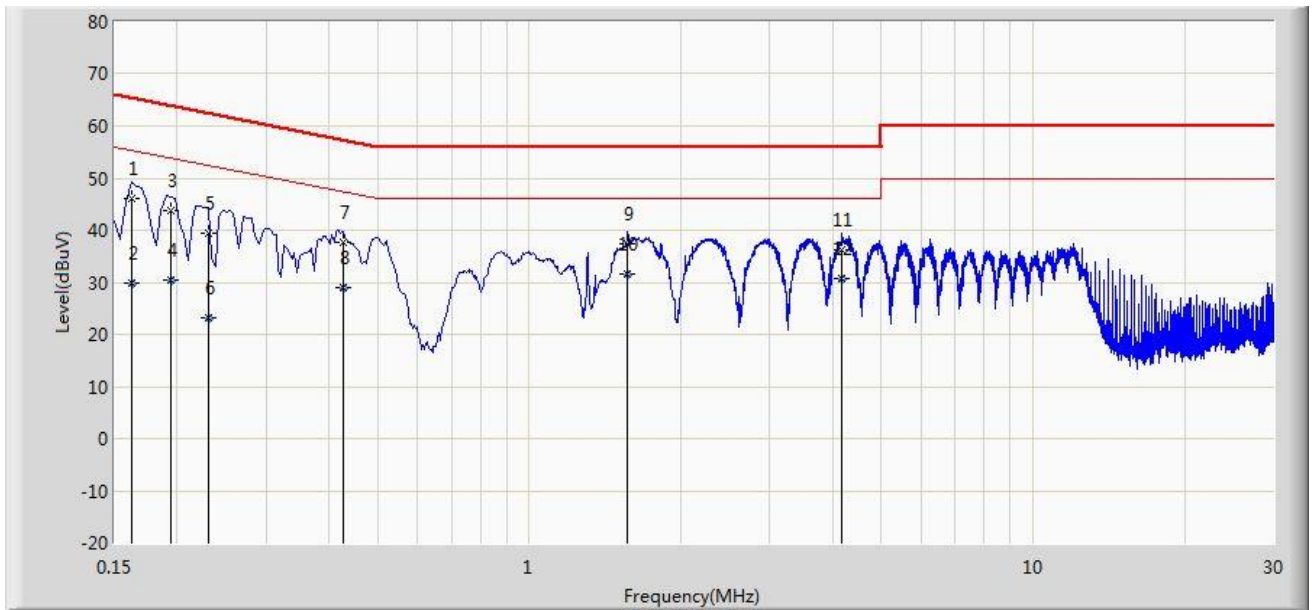

No	Flag	Mark	Frequency (MHz)	Measure Level (dBuV)	Reading Level (dBuV)	Over Limit (dB)	Limit (dBuV)	Factor (dB)	Type
1			0.162	45.960	35.881	-19.401	65.361	10.078	QP
2			0.162	29.873	19.795	-25.488	55.361	10.078	AV
3			0.194	43.842	33.821	-20.022	63.864	10.021	QP
4			0.194	30.427	20.406	-23.437	53.864	10.021	AV
5			0.230	39.385	29.400	-23.064	62.450	9.985	QP
6			0.230	23.319	13.333	-29.131	52.450	9.985	AV
7			0.426	37.553	27.421	-19.777	57.330	10.132	QP
8			0.426	28.929	18.797	-18.402	47.330	10.132	AV
9			1.566	37.334	27.447	-18.666	56.000	9.887	QP
10		*	1.566	31.707	21.820	-14.293	46.000	9.887	AV
11			4.178	36.189	26.206	-19.811	56.000	9.983	QP
12			4.178	30.583	20.600	-15.417	46.000	9.983	AV

Note: Measure Level (dBμV) = Reading Level (dBμV) + Factor (dB)

Factor (dB) = Cable Loss (dB) + LISN Factor (dB).

4.5. Test Photograph

Test Mode: Mode 1

Description: Front View Conducted Emission Test Setup



Test Mode: Mode 1

Description: Back View Conducted Emission Test Setup

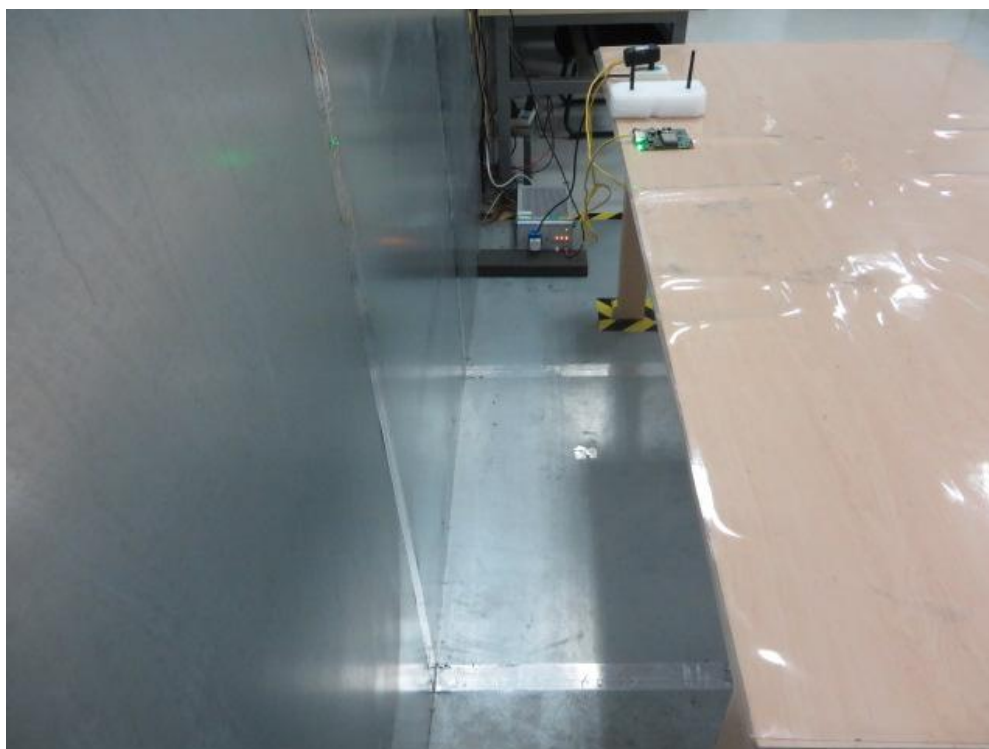

5. Radiated Emission

5.1. Limit of Radiated Emission

Frequency range MHz	Quasi-peak limits dB(μ V/m)
30 to 230	40
230 to 1000	47

Note 1: The lower limit shall apply at the transition frequency.

Note 2: Additional provisions may be required for cases where interference occurs.

Frequency range GHz	Average limit dB(μ V/m)	Peak limit dB(μ V/m)
1 to 3	50	70
3 to 6	54	74

Note: The lower limit applies at the transition frequency.

5.2. Test Setup

30 MHz ~ 1000 MHz

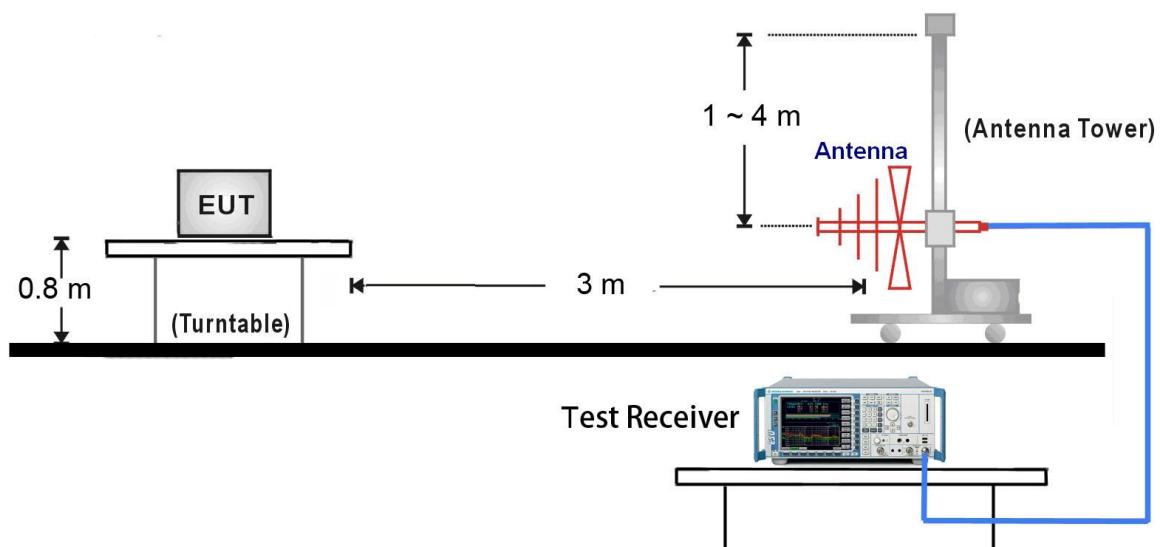

1000 MHz ~ 6000 MHz

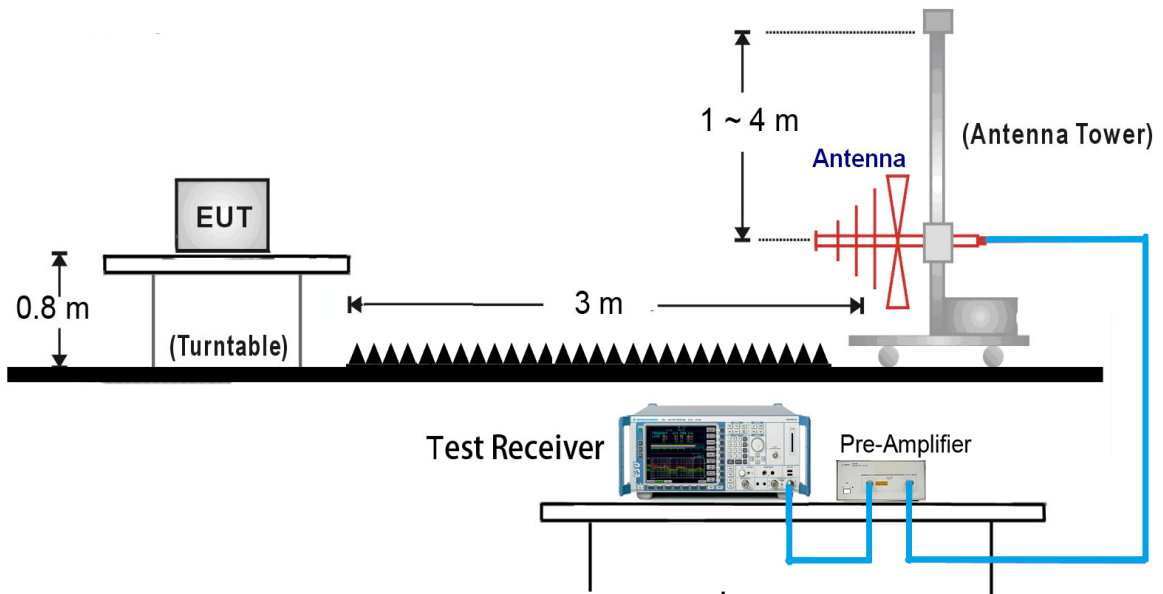

5.3. Test Procedure

Starting with the front of the receiver under test facing the measuring antenna, the measuring antenna is adjusted for horizontal polarization measurement and its height varied between 1 m and 4 m until the maximum reading is obtained.

The receiver under test is then rotated about its centre until the maximum meter reading is obtained, after which the measuring antenna height is again varied between 1 m and 4 m and the maximum reading noted.

The procedure is repeated for vertical polarization of the measuring antenna.

The highest value found, following this procedure, is defined as the radiation figure of the receiver.

If at certain frequencies the ambient signal field strength is high at the position of the receiving antenna, one of the following methods may be used to show compliance of the equipment under test.

- a) For small frequency bands with high ambient signals, the disturbance value may be interpolated from the adjacent values. The interpolated value shall lie on the curve describing a continuous function of the disturbance values adjacent to the ambient noise.
- b) Another possibility is to use the method described in annex C of CISPR 11.

5.4. Test Result

Site: AC1	Time: 2015/06/12 - 19:56
Limit: EN55022_RE(3m)_ClassB	Engineer: Milo Li
Probe: VULB9162_0.03-8GHz	Polarity: Horizontal
EUT: 802.11ac Dual Band Module	Power: AC 230V/50Hz
Mode 1: Communication	

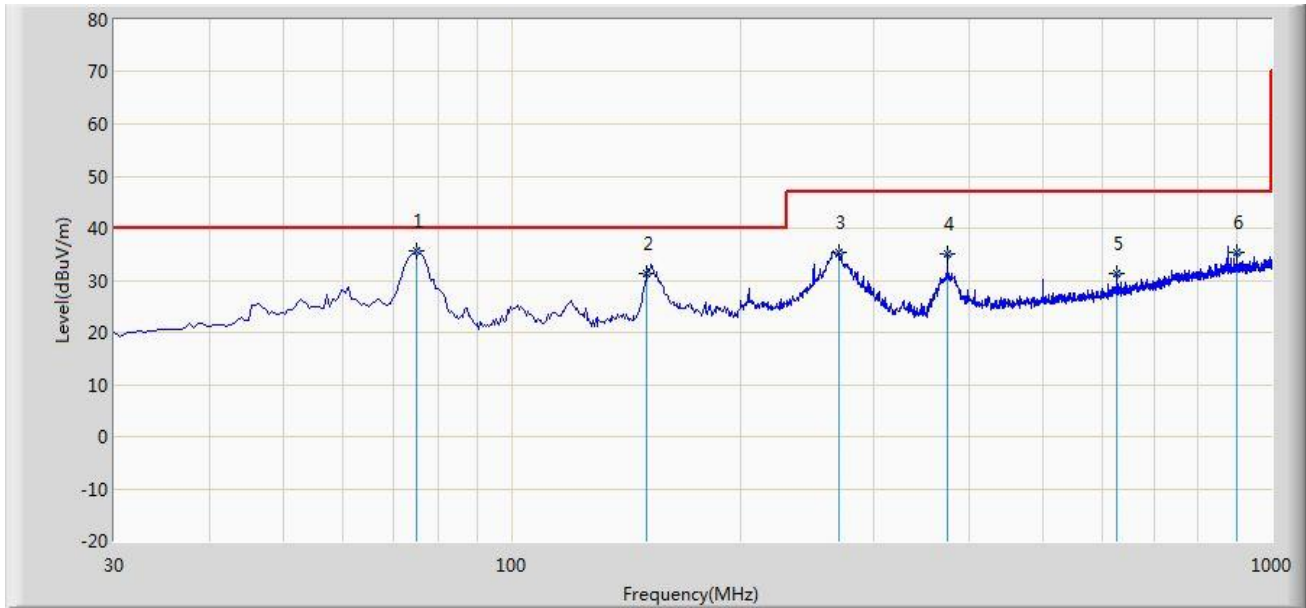

No	Flag	Mark	Frequency (MHz)	Measure Level (dBuV/m)	Reading Level (dBuV)	Over Limit (dB)	Limit (dBuV/m)	Factor (dB)	Type
1		*	75.105	35.721	26.220	-4.279	40.000	9.501	QP
2			150.765	31.435	22.239	-8.565	40.000	9.196	QP
3			270.075	35.483	21.840	-11.517	47.000	13.643	QP
4			374.835	35.003	19.273	-11.997	47.000	15.730	QP
5			625.095	31.173	11.450	-15.827	47.000	19.723	QP
6			900.090	35.428	12.109	-11.572	47.000	23.319	QP

Note: Measure Level (dB μ V/m) = Reading Level (dB μ V) + Factor (dB)

Factor (dB) = Cable Loss (dB) + Antenna Factor (dB/m).

Site: AC1	Time: 2015/06/12 - 19:57
Limit: EN55022_RE(3m)_ClassB	Engineer: Milo Li
Probe: VULB9162_0.03-8GHz	Polarity: Vertical
EUT: 802.11ac Dual Band Module	Power: AC 230V/50Hz
Mode 1: Communication	

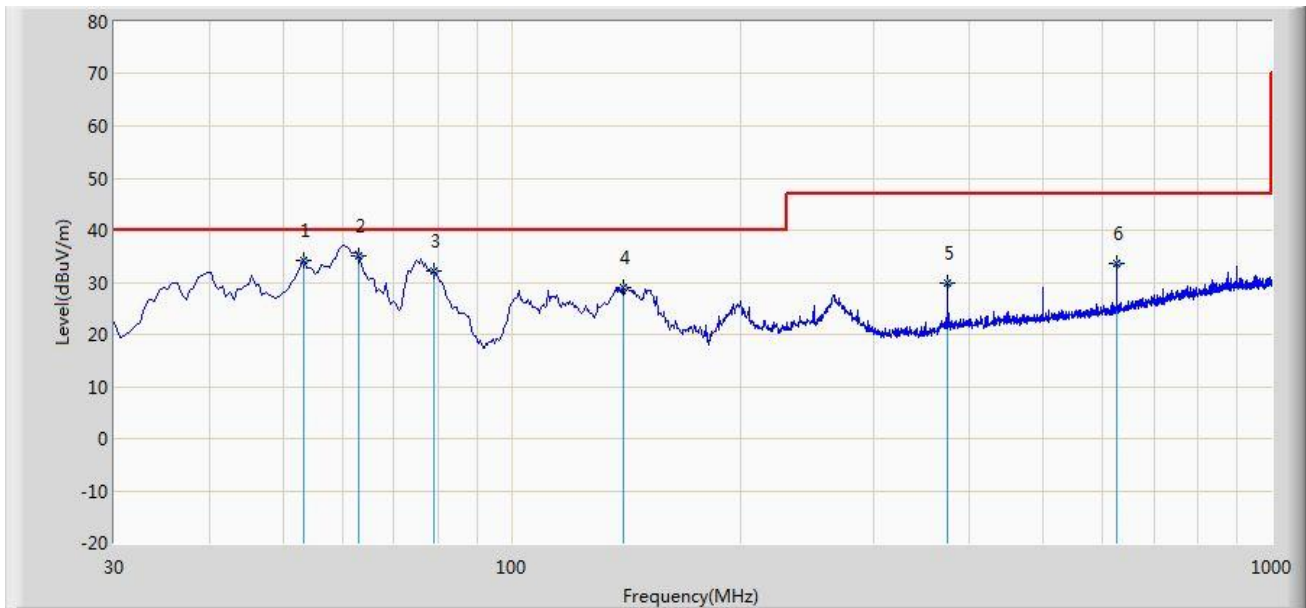

No	Flag	Mark	Frequency (MHz)	Measure Level (dBuV/m)	Reading Level (dBuV)	Over Limit (dB)	Limit (dBuV/m)	Factor (dB)	Type
1			53.280	34.110	19.419	-5.890	40.000	14.691	QP
2		*	62.980	35.139	22.130	-4.861	40.000	13.009	QP
3			78.985	32.031	23.006	-7.969	40.000	9.025	QP
4			140.580	28.992	19.806	-11.008	40.000	9.186	QP
5			374.835	29.762	14.032	-17.238	47.000	15.730	QP
6			625.095	33.632	13.909	-13.368	47.000	19.723	QP

Note: Measure Level (dB μ V/m) = Reading Level (dB μ V) + Factor (dB)

Factor (dB) = Cable Loss (dB) + Antenna Factor (dB/m).

Site: AC1	Time: 2015/06/12 - 20:02
Limit: EN55022_RE(3m)_ClassB	Engineer: Milo Li
Probe: BBHA9120D_1-18GHz	Polarity: Horizontal
EUT: 802.11ac Dual Band Module	Power: AC 230V/50Hz
Mode 1: Communication	

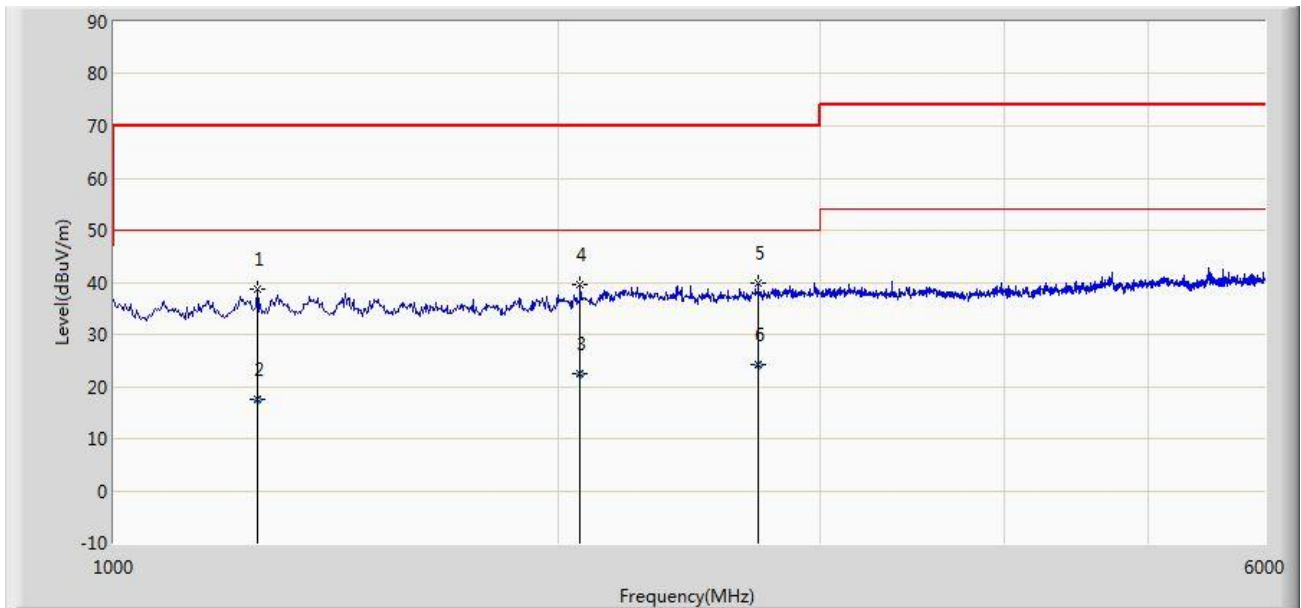

No	Flag	Mark	Frequency (MHz)	Measure Level (dBuV/m)	Reading Level (dBuV)	Over Limit (dB)	Limit (dBuV/m)	Factor (dB)	Type
1			1250.000	38.820	47.373	-31.180	70.000	-8.553	PK
2			1250.810	17.664	26.210	-32.336	50.000	-8.546	AV
3			2067.410	22.332	27.400	-27.668	50.000	-5.068	AV
4			2067.500	39.642	44.709	-30.358	70.000	-5.067	PK
5			2727.500	39.783	42.384	-30.217	70.000	-2.601	PK
6		*	2727.510	24.339	26.940	-25.661	50.000	-2.601	AV

Note: Measure Level (dB μ V/m) = Reading Level (dB μ V) + Factor (dB)

Factor (dB) = Cable Loss (dB) + Antenna Factor (dB/m) – Pre_Amplifier Gain (dB).

Site: AC1	Time: 2015/06/12 - 20:03
Limit: EN55022_RE(3m)_ClassB	Engineer: Milo Li
Probe: BBHA9120D_1-18GHz	Polarity: Vertical
EUT: 802.11ac Dual Band Module	Power: AC 230V/50Hz
Mode 1: Communication	

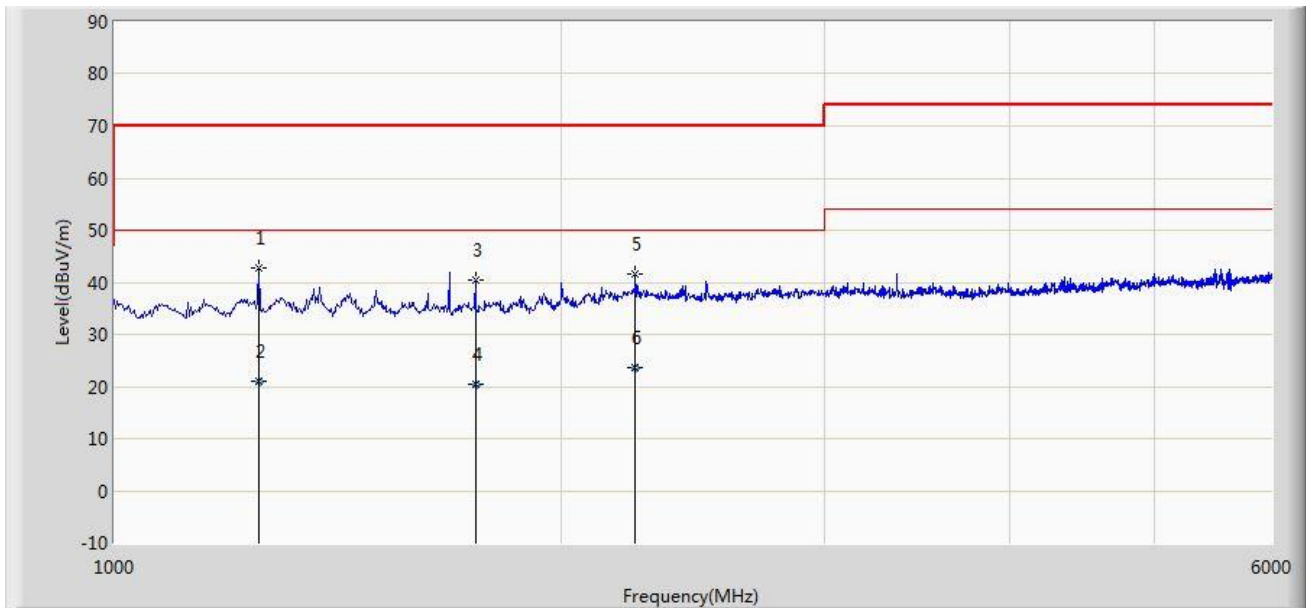

No	Flag	Mark	Frequency (MHz)	Measure Level (dBuV/m)	Reading Level (dBuV)	Over Limit (dB)	Limit (dBuV/m)	Factor (dB)	Type
1			1250.000	42.633	51.186	-27.367	70.000	-8.553	PK
2			1250.140	21.129	29.680	-28.871	50.000	-8.551	AV
3			1750.000	40.575	47.821	-29.425	70.000	-7.246	PK
4			1750.140	20.375	27.620	-29.625	50.000	-7.245	AV
5			2240.000	41.483	44.960	-28.517	70.000	-3.477	PK
6		*	2240.140	23.488	26.965	-26.512	50.000	-3.477	AV

Note: Measure Level (dB μ V/m) = Reading Level (dB μ V) + Factor (dB)

Factor (dB) = Cable Loss (dB) + Antenna Factor (dB/m) – Pre_Amplifier Gain (dB).

5.5. Test Photograph

Test Mode: Mode 1

Description: Radiated Emission Test Setup (30MHz ~ 1GHz)



Test Mode: Mode 1

Description: Radiated Emission Test Setup (1GHz ~ 6GHz)

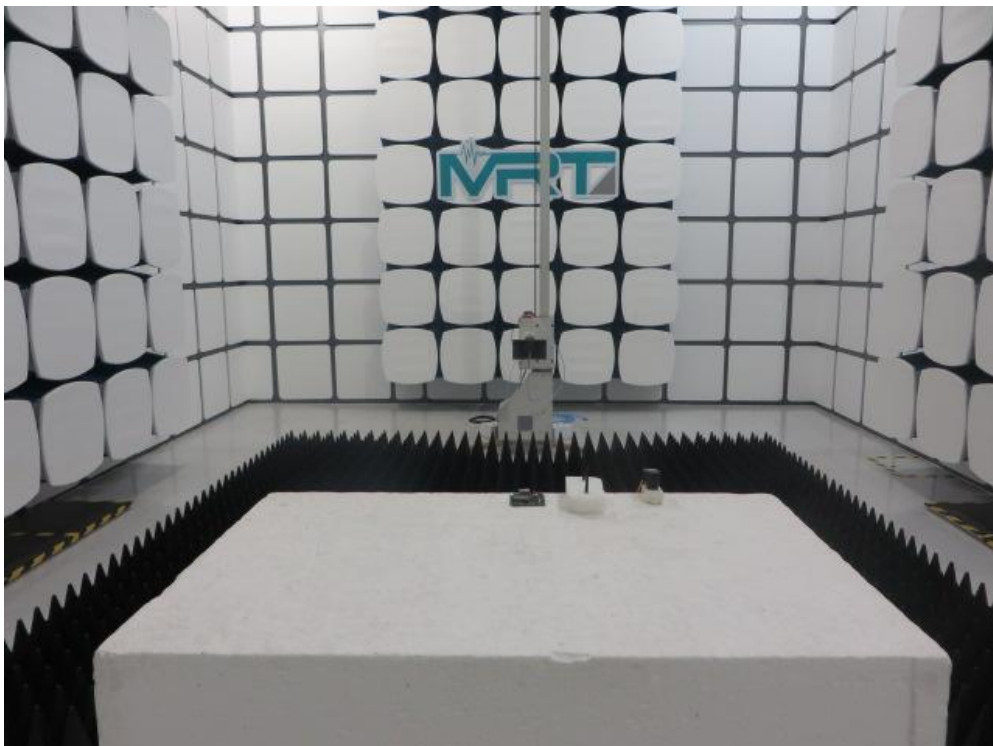

6. Harmonic Current Emissions

6.1. Limit of Harmonic Current Emissions

Limits of Class A Harmonics Currents

Harmonics Order n	Maximum Permissible harmonic current A	Harmonics Order n	Maximum Permissible harmonic current A
Odd harmonics		Even harmonics	
3	2.30	2	1.08
5	1.14	4	0.43
7	0.77	6	0.30
9	0.40	$8 \leq n \leq 40$	$0.23 * 8/n$
11	0.33	--	--
13	0.21	--	--
$15 \leq n \leq 39$	$0.15 * 15/n$	--	--

6.2. Test Setup

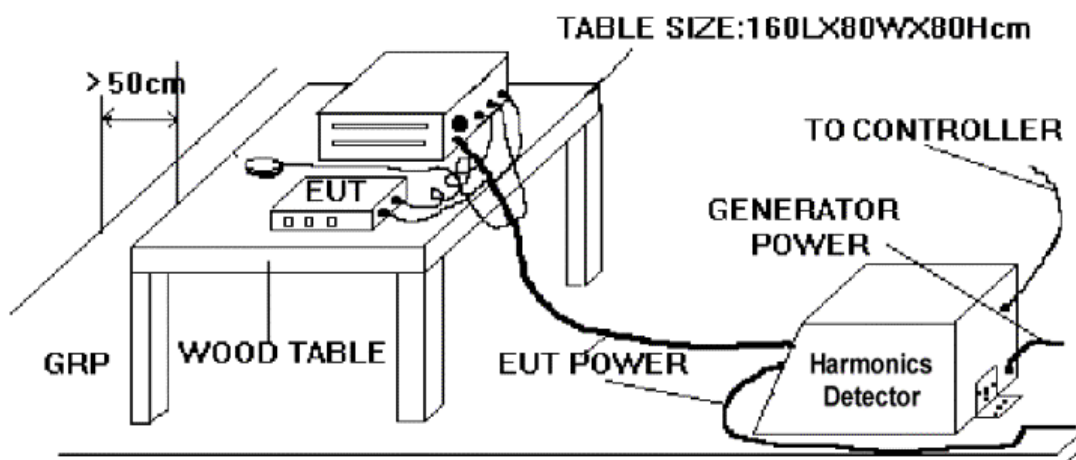

6.3. Test Procedure

The EUT is supplied in series with power analyzer from a power source having the same normal voltage and frequency as the rated supply voltage and the equipment under test. And the rated voltage at the supply voltage of EUT of 0.98 times and 1.02 times shall be performed.

6.4. Test Result

Product	802.11ac Dual Band Module	Temperature	24°C
Test Engineer	Roy Cheng	Relative Humidity	52%
Test Mode	Mode 1	Date of Test	2015/05/19

Test Result: Pass

Source qualification: Normal

Current & voltage waveforms

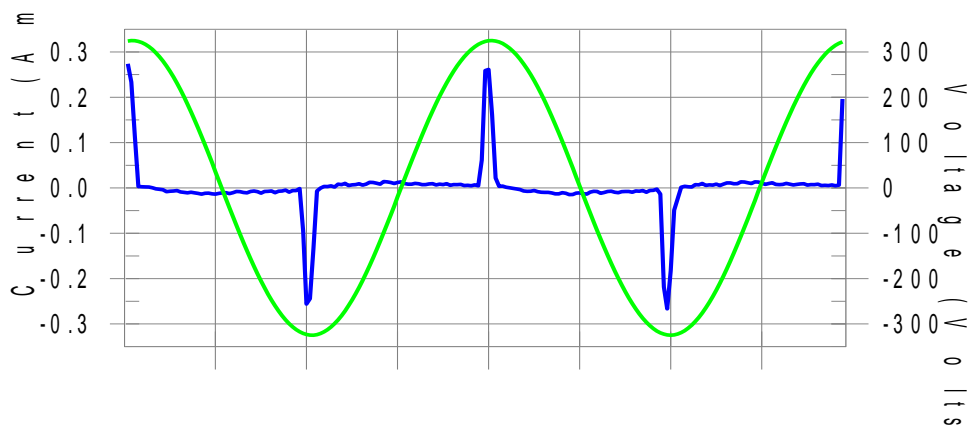

Harmonics and Class A limit line European Limits

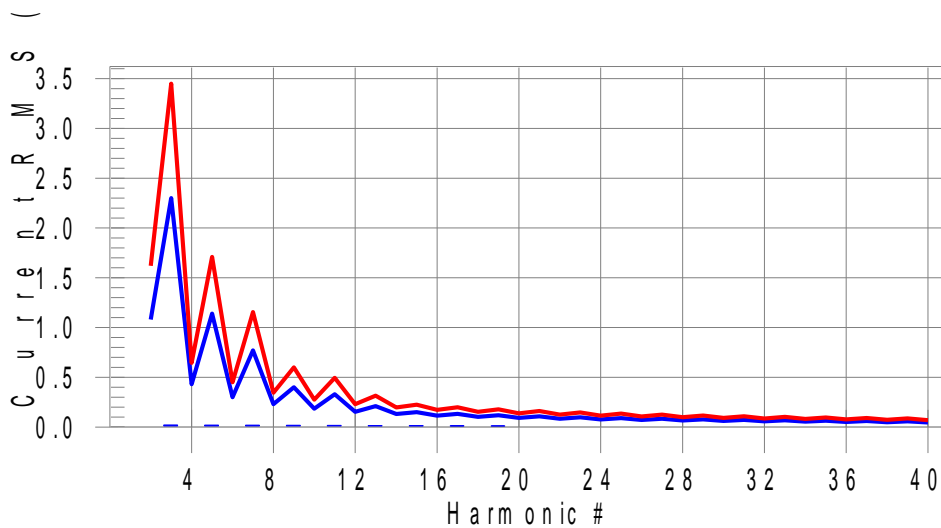

Test result: Pass Worst harmonic was #17 with 9.18% of the limit.

Test Result: Pass

Source qualification: Normal

THC(A): 0.06

I-THD(%): 221.26

POHC(A): 0.023

POHC Limit(A): 0.251

Highest parameter values during test:

V_RMS (Volts): 229.87

Frequency(Hz): 50.00

I_Peak (Amps): 0.355

I_RMS (Amps): 0.062

I_Fund (Amps): 0.026

Crest Factor: 5.802

Power (Watts): 4.6

Power Factor: 0.328

Harm#	Harms(avg)	100%Limit	%of Limit	Harms(max)	150%Limit	%of Limit	Status
2	0.001	1.080	0.1	0.001	1.620	0.06	Pass
3	0.019	2.300	0.8	0.020	3.450	0.59	Pass
4	0.001	0.430	0.1	0.001	0.645	0.12	Pass
5	0.019	1.140	1.7	0.019	1.710	1.12	Pass
6	0.000	0.300	0.1	0.001	0.450	0.11	Pass
7	0.018	0.770	2.4	0.019	1.155	1.63	Pass
8	0.000	0.230	0.1	0.000	0.345	0.10	Pass
9	0.018	0.400	4.4	0.018	0.600	2.98	Pass
10	0.000	0.184	0.1	0.000	0.276	0.13	Pass
11	0.017	0.330	5.2	0.017	0.495	3.45	Pass
12	0.000	0.153	0.2	0.000	0.230	0.16	Pass
13	0.016	0.210	7.7	0.016	0.315	5.17	Pass
14	0.000	0.131	0.2	0.000	0.197	0.17	Pass
15	0.015	0.150	10.1	0.015	0.225	6.78	Pass
16	0.000	0.115	0.2	0.000	0.173	0.19	Pass
17	0.014	0.132	10.7	0.014	0.199	7.14	Pass
18	0.000	0.102	0.2	0.000	0.153	0.21	Pass
19	0.013	0.118	11.0	0.013	0.178	7.34	Pass
20	0.000	0.092	0.3	0.000	0.138	0.26	Pass
21	0.012	0.107	11.0	0.012	0.161	7.35	Pass
22	0.000	0.084	0.3	0.000	0.125	0.26	Pass
23	0.011	0.098	10.9	0.011	0.147	7.25	Pass
24	0.000	0.077	0.3	0.000	0.115	0.28	Pass
25	0.009	0.090	10.5	0.009	0.135	7.01	Pass
26	0.000	0.071	0.3	0.000	0.106	0.30	Pass
27	0.008	0.083	9.9	0.008	0.125	6.62	Pass
28	0.000	0.066	0.3	0.000	0.099	0.32	Pass
29	0.007	0.078	9.2	0.007	0.116	6.17	Pass
30	0.000	0.061	0.3	0.000	0.092	0.31	Pass
31	0.006	0.073	8.3	0.006	0.109	5.58	Pass
32	0.000	0.058	0.4	0.000	0.086	0.34	Pass
33	0.005	0.068	7.4	0.005	0.102	4.98	Pass
34	0.000	0.054	0.3	0.000	0.081	0.31	Pass
35	0.004	0.064	6.4	0.004	0.096	4.33	Pass
36	0.000	0.051	0.3	0.000	0.077	0.32	Pass
37	0.003	0.061	5.4	0.003	0.091	3.67	Pass
38	0.000	0.048	0.3	0.000	0.073	0.31	Pass
39	0.003	0.058	4.5	0.003	0.087	3.04	Pass
40	0.000	0.046	0.3	0.000	0.069	0.31	Pass

6.5. Test Photograph

Test Mode: Mode 1

Description: Harmonic current emissions Test Setup



7. Voltage Fluctuations and Flicker

7.1. Limit of Voltage Fluctuations and Flicker

The following limits apply:

- the value of P_{st} shall not be greater than 1.0;
- the value of P_{lt} shall not be greater than 0.65;
- the value of $d(t)$ during a voltage change shall not exceed 3.3% for more than 500ms;
- the relative steady-state voltage change, d_c , shall not exceed 3.3%;
- the maximum relative voltage change, d_{max} , shall not exceed:
 - a) 4% without additional conditions;
 - b) 6% for equipment which is:
 - switched manually, or
 - switched automatically more frequently than twice per day, and also has either a delayed restart (the delay being not less than a few tens of seconds), or manual restart, after a power supply interruption.

NOTE: The cycling frequency will be further limited by the P_{st} and P_{lt} limit.

For example: a d_{max} of 6% producing a rectangular voltage change characteristic twice per hour will give a P_{lt} of about 0.65.

- c) 7% for equipment which is:
 - attended whilst in use (for example: hair dryers, vacuum cleaners, kitchen equipment such as mixers, garden equipment such as lawn mowers, portable tools such as electric drills), or
 - switched on automatically, or is intended to be switched on manually, no more than twice per day, and also has either a delayed restart (the delay being not less than a few tens of seconds) or manual restart, after a power supply interruption.

P_{st} and P_{lt} requirements shall not be applied to voltage changes caused by manual switching.

7.2. Test Setup

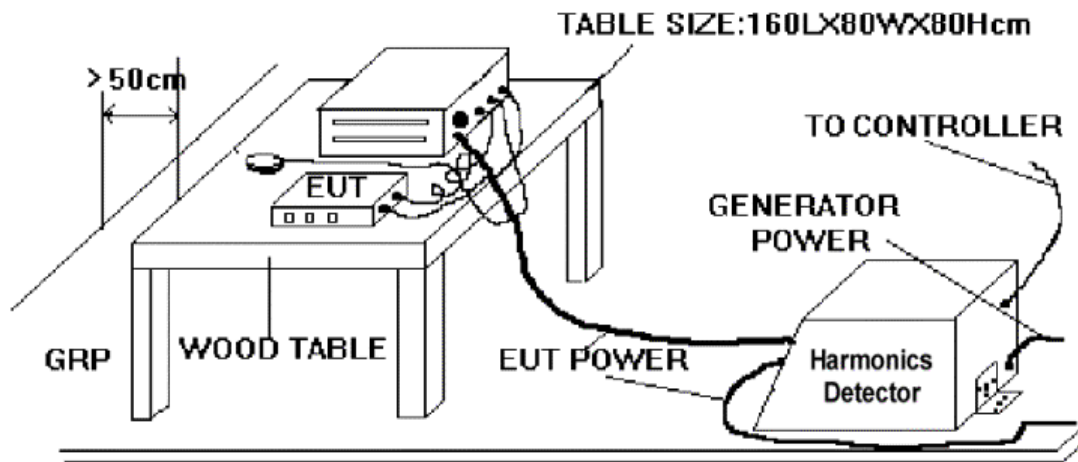

7.3. Test Procedure

The EUT is supplied in series with power analyzer from a power source having the same normal voltage and frequency as the rated supply voltage and the equipment under test. And the rated voltage at the supply voltage of EUT of 0.98 times and 1.02 times shall be performed.

7.4. Test Result

Product	802.11ac Dual Band Module	Temperature	24°C
Test Engineer	Roy Cheng	Relative Humidity	52%
Test Mode	Mode 1	Date of Test	2015/05/19

Test Result: Pass

Status: Test Completed

Pstj and limit line

European Limits

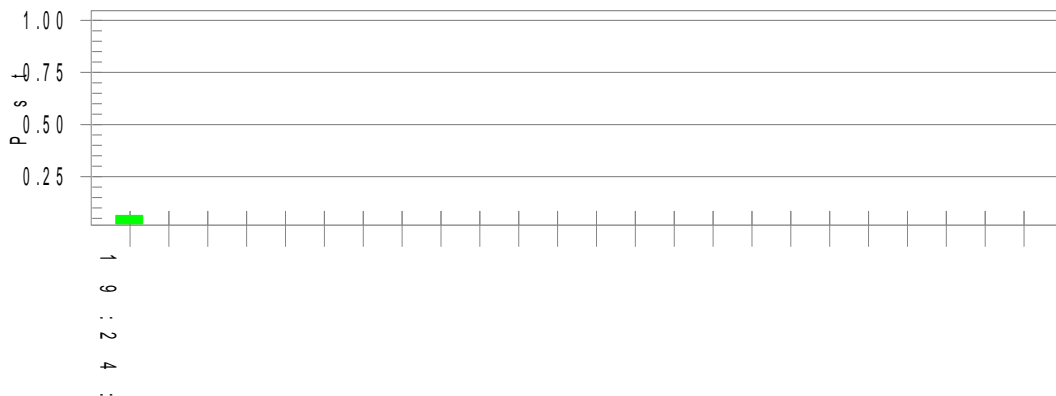

Plt and limit line

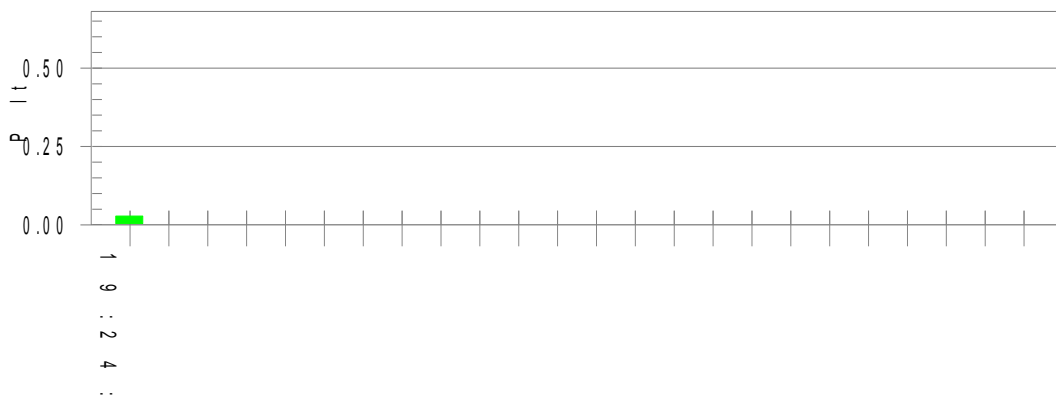

Parameter values recorded during the test:

Vrms at the end of test (Volt):	229.82		
Highest dt (%):	0.00	Test limit (%):	3.30 Pass
Time(mS) > dt:	0.0	Test limit (mS):	500.0 Pass
Highest dc (%):	0.00	Test limit (%):	3.30 Pass
Highest dmax (%):	0.00	Test limit (%):	4.00 Pass
Highest Pst (10 min. period):	0.064	Test limit:	1.000 Pass
Highest Plt (2 hr. period):	0.028	Test limit:	0.650 Pass

7.5. Test Photograph

Test Mode: Mode 1

Description: Voltage Fluctuation and Flicker Test Setup



8. Electrostatic Discharge

8.1. Limit of Electrostatic Discharge

Environmental phenomenon	Test specification	Units	Performance criterion
Enclosure port			
Electrostatic discharge	±4 (Contact discharge)	kV (Charge voltage)	B
	±8 (Air discharge)	kV (Charge voltage)	

8.2. Test Setup

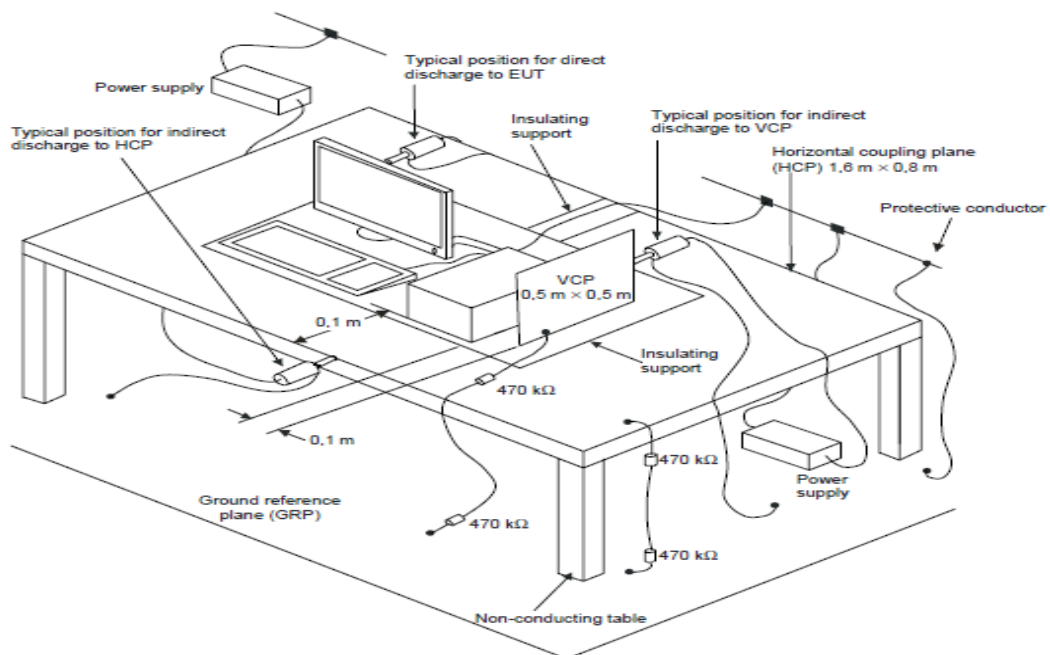

8.3. Test Procedure

Direct application of discharges to the EUT:

Contact discharge was applied only to conductive surfaces of the EUT.

Air discharges were applied only to non-conductive surfaces of the EUT.

During the test, it was performed with single discharges. For the single discharge time between successive single discharges will be keep longer 1 second. It was at least twenty-five single discharges with positive and negative at the same selected point.

The selected point, which was performed with electrostatic discharge, was marked on the red label of the EUT.

Indirect application of discharges to the EUT:

Vertical Coupling Plane (VCP):

The coupling plane, of dimensions 0.5m x 0.5m, is placed parallel to, and positioned at a distance 0.1m from the EUT, with the Discharge Electrode touching the coupling plane.

The four faces of the EUT will be performed with electrostatic discharge. It was at least twenty-five single discharges with positive and negative at the same selected point.

Horizontal Coupling Plane (HCP):

The coupling plane is placed under to the EUT. The generator shall be positioned vertically at a distance of 0.1m from the EUT, with the Discharge Electrode touching the coupling plane.

The four faces of the EUT will be performed with electrostatic discharge. It was at least twenty-five single discharges with positive and negative at the same selected point.

8.4. Test Result

EUT	802.11ac Dual Band Module	Temperature	23°C
Test Engineer	Roy Cheng	Relative Humidity	54%
Test Mode	Mode 1	Date of Test	2015/05/15

Indirect Application		Test Result	
Test Location	Test Level	Horizontal Coupling	Vertical Coupling
Front, Rear Left, Right	±4kV	Pass	Pass

Note: There is no any degradation of performance and function, and the EUT performance complied with performance criteria for TT&TR to MS Function.

8.5. Test Photograph

Test Mode: Mode 1

Description: Electrostatic Discharge Test Setup



9. Radio-frequency Electromagnetic Field

9.1. Limit of Radio-frequency Electromagnetic Field

Environmental phenomenon	Test specification	Units	Performance criterion
Enclosure port			
Radio frequency electromagnetic field	80 - 1000, 1400 - 2700	MHz	A
	3	V/m (unmodulated, r.m.s)	
	80	% AM (1kHz)	
Note 1: If the wanted signal is modulated at 1000Hz, then an audio signal of 400Hz shall be used. Note 2: The test shall be performed over the frequency range 80MHz to 1000MHz and 1400MHz to 2700MHz with the exception of the exclusion band for transmitters, receivers and duplex transceivers [see clause 4 of EN 301 489-1 V1.9.2 (2010-09)], as appropriate.			

9.2. Test Setup

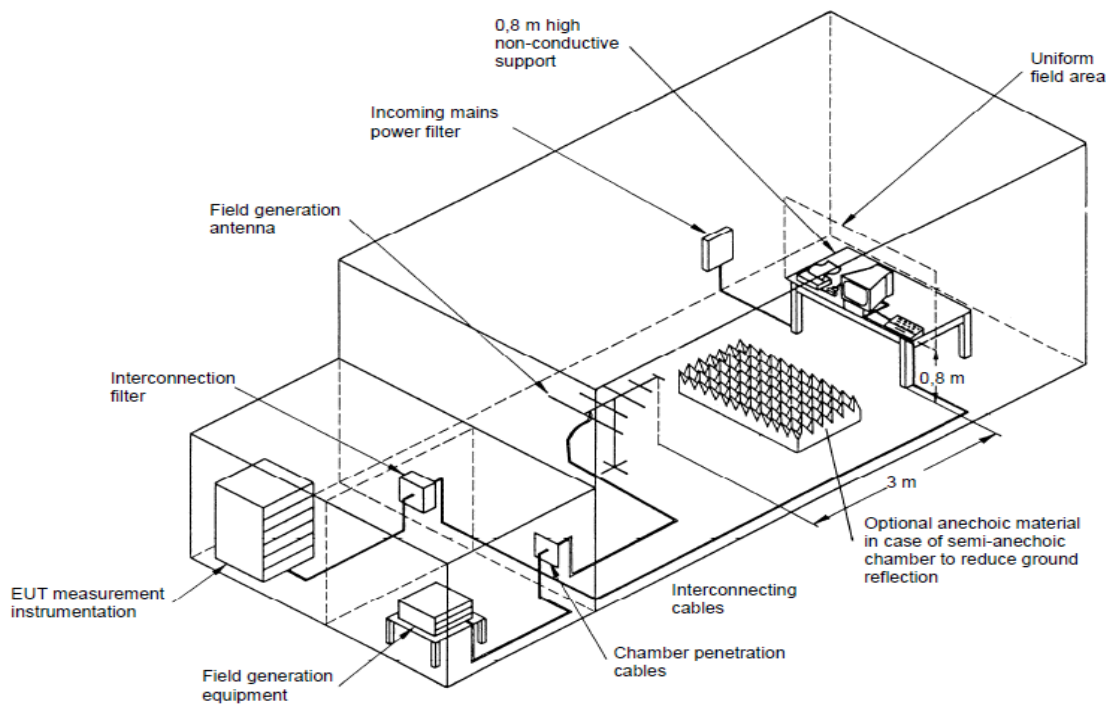

9.3. Test Procedure

The EUT and load, which are placed on a table that is 0.8 meter above ground, are placed with one coincident with the calibration plane such that the distance from antenna to the EUT was 3 meters. Both horizontal and vertical polarization of the antenna and four sides of the EUT are set on measurement.

In order to judge the EUT performance, a CCD camera is used to monitor the PC (1) screen which shows the communication status.

All the scanning conditions are as follows:

	Condition of Test	Remarks
1.	Field Strength	3V/m
2.	Radiated Signal	AM 80% Modulated with 1kHz
3.	Scanning Frequency	80 - 1000MHz, 1.4GHz - 2.7GHz
4.	Dwell Time	3 Seconds
5.	Frequency Step Size Δf	1%

9.4. Test Result

EUT	802.11ac Dual Band Module	Temperature	23°C
Test Engineer	Roy Cheng	Relative Humidity	54%
Test Mode	Mode 1	Date of Test	2015/05/12

Frequency (MHz)	Polarity	Test Position	Field Strength (V/m)	Test Result
80-1000	Horizontal/Vertical	Front	3	Pass
		Rear		Pass
		Left		Pass
		Right		
		Top		
		Bottom		Pass
1400-2700	Horizontal/Vertical	Front	3	Pass
		Rear		Pass
		Left		
		Right		
		Top		Pass
		Bottom		Pass

Note: There is no any degradation of performance and function, and the EUT performance complied with performance criteria for CT&CR to MS Function.

9.5. Test Photograph

Test Mode: Mode 1

Description: Radio-frequency Electromagnetic Field Test Setup



10. Electrical Fast Transients

10.1. Limit of Electrical Fast Transients

Environmental phenomenon	Test specification	Units	Performance criterion
Input AC power ports			
Electrical fast transients	±1 5/50 5	kV (open circuit test voltage) Tr/Th (ns) Repetition frequency (kHz)	B
Signal ports, telecommunication ports, and control ports (See Note)			
Fast transients common mode	±0.5 5/50 5	kV (peak) Tr/Th ns Repetition frequency (kHz)	B

NOTE: This test shall be additionally performed on signal ports, telecommunication ports, control ports, and DC power ports, of radio equipment and associated ancillary equipment, if the cables may be longer than 3m.

10.2. Test Setup

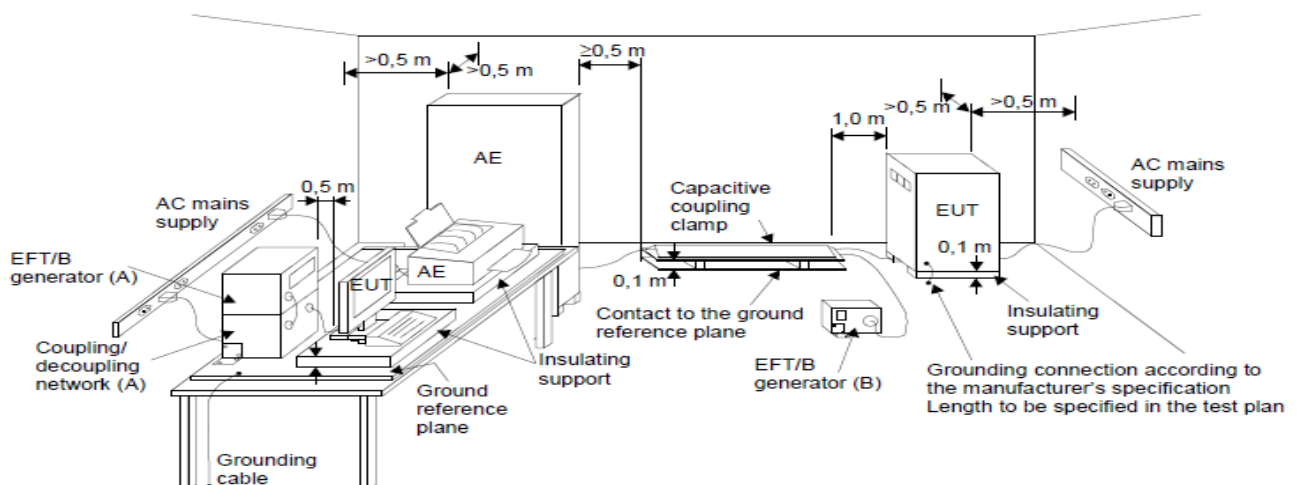

10.3. Test Procedure

The EUT is placed on a table that is 0.8 meter height. A ground reference plane is placed on the table, and uses a 0.1m insulation between the EUT and ground reference plane.

The minimum area of the ground reference plane is 1m*1m, and 0.65mm thick min, and projected beyond the EUT by at least 0.1m on all sides.

For input AC power ports:

The EUT is connected to the power mains through a coupling device that directly couples the EFT/B interference signal.

Each of the line conductors is impressed with burst noise for 1 minute.

The length of the power lines between the coupling device and the EUT is 0.5m.

For signal ports, telecommunication ports, and control ports:

The EFT interference signal is through a coupling clamp device couples to the signal of the EUT with burst noise for 1 minute.

The length of the signal lines between the coupling device and the EUT is 0.5m.

10.4. Test Result

Product	802.11ac Dual Band Module	Temperature	24°C
Test Engineer	Roy Cheng	Relative Humidity	54%
Test Mode	Mode 1	Date of Test	2015/05/16

Inject Line	Polarity	Test Level (kV)	Test Duration (second)	Inject Method	Observation	Result
L	+	1	60	Direct	Note	Pass
L	-	1	60	Direct	Note	Pass
N	+	1	60	Direct	Note	Pass
N	-	1	60	Direct	Note	Pass
L+N	+	1	60	Direct	Note	Pass
L+N	-	1	60	Direct	Note	Pass

Note: There is no any degradation of performance and function, and the EUT performance complied with performance criteria for TT&TR to MS Function.

10.5. Test Photograph

Test Mode: Mode 1

Description: Electrical Fast Transients Test Setup



11. Surges

11.1. Limit of Surges

Environmental phenomenon	Test specification	Units	Performance criterion
Input AC power ports (See Note 1)			
Surges	1.2/50 (8/20) ±1 line to line ±2 line to earth	Tr/Th (us) kV (open circuit test voltage) kV (open circuit test voltage)	B
Telecommunication ports directly connected to indoor cables (See Note 1 and 2)			
Surges	1.2/50 (8/20) 0.5 line to ground	Tr/Th us kV (peak)	B
NOTE 1: Where normal functioning cannot be achieved because of the impact of the CDN on the EUT, no test shall be required.			
NOTE 2: The test level for telecommunication ports, intended to be connected to indoor cables (longer than 10m) shall be 0.5kV line to ground.			

11.2. Test Setup

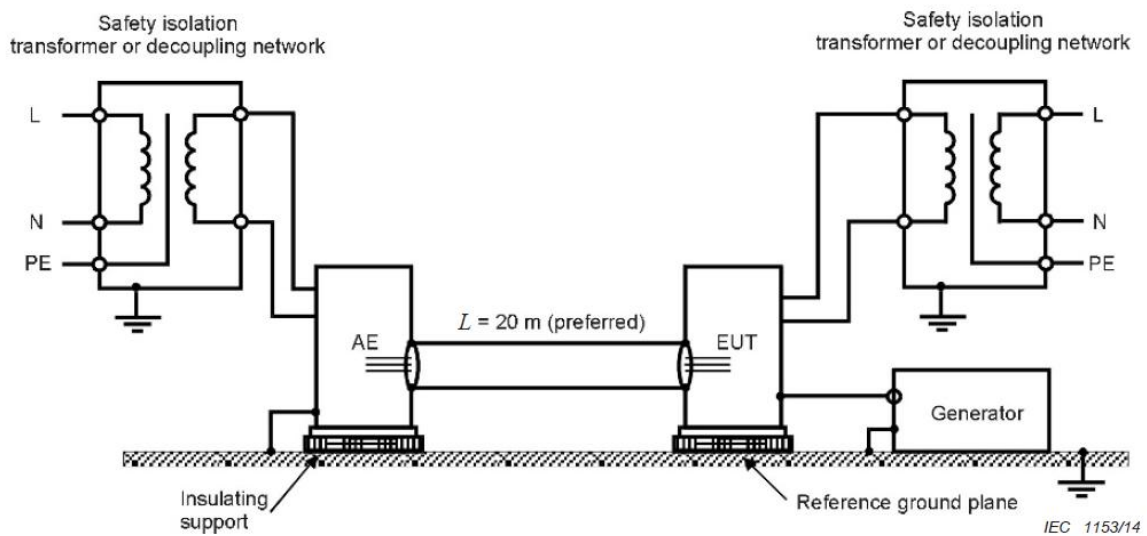

11.3. Test Procedure

The EUT is placed on a table that is 0.8 meter above a metal ground plane measured 1m*1m minimum and 0.65mm thick minimum and projected beyond the EUT by at least 0.1m on all sides. The length of power cord between the coupling device and the EUT shall be 2m or less.

For input AC power ports:

The EUT is connected to the power mains through a coupling device that directly couples the surge interference signal.

The surge noise shall be applied synchronized to the voltage phase at 0° , 90° , 180° , 270° and the peak value of the AC voltage wave. (Positive and negative)

Each of Line to Earth and Line to Line is impressed with a sequence of five surge voltages with interval of 1 minute.

For telecommunication ports:

The signal line of EUT is connected to coupling and decoupling network that directly couples the surge interference signal.

Only Line to ground is impressed with a sequence of five surge voltages with interval of 1 minute.

11.4. Test Result

Product	802.11ac Dual Band Module	Temperature	24°C
Test Engineer	Roy Cheng	Relative Humidity	54%
Test Mode	Mode 1	Date of Test	2015/05/16

Inject Line	Polarity	Angle (degree)	Test Level (kV)	Test Interval (second)	Observation	Result
L+N	+	0	0.5&1	60	Note	Pass
L+N	-	0	0.5&1	60	Note	Pass
L+N	+	90	0.5&1	60	Note	Pass
L+N	-	90	0.5&1	60	Note	Pass
L+N	+	180	0.5&1	60	Note	Pass
L+N	-	180	0.5&1	60	Note	Pass
L+N	+	270	0.5&1	60	Note	Pass
L+N	-	270	0.5&1	60	Note	Pass

Note: There is no any degradation of performance and function, and the EUT performance complied with performance criteria for TT&TR to MS Function.

11.5. Test Photograph

Test Mode: Mode 1

Description: Surge Test Setup



12. Radio-frequency Common Mode

12.1. Limit of Radio-frequency Common Mode

Environmental phenomenon	Test specification	Units	Performance criterion
Input AC power ports (See Note 1 and 2)			
Radio-frequency common mode	0.15 - 80	MHz	A
	3	V (unmodulated, r.m.s)	
	80	% AM (1kHz)	
Signal ports, telecommunication ports, and control ports (See Note 1, 2 and 3)			
Radio frequency common mode	0.15 - 80	MHz	A
	3	V (unmodulated, r.m.s)	
	80	% AM (1kHz)	
NOTE 1: If the wanted signal is modulated at 1000Hz, then an audio signal of 400Hz shall be used.			
NOTE 2: The test shall be performed over the frequency range 150kHz to 80MHz with the exception of the exclusion band for transmitters, and for receivers and duplex transceivers [see clause 4 of EN 301 489-1 V1.9.2 (2011-09)].			
NOTE 3: This test shall be additionally performed on signal ports, telecommunication ports, control ports, and DC power ports, of radio equipment and associated ancillary equipment, if the cables may be longer than 3m.			

12.2. Test Setup

CDN Test Setup

T : 50 ohm

T2: Power attenuator(6dB)

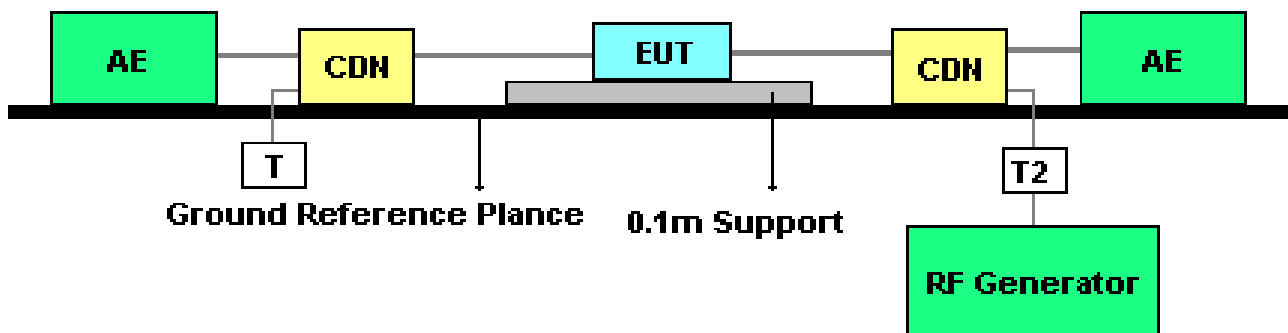

12.3. Test Procedure

The EUT is placed on a table that is 0.8 meter height, and a ground reference plane on the table, EUT is placed upon table and use 0.1m insulation between the EUT and ground reference plane.

For input AC power ports:

The EUT is connected to the power mains through a coupling and decoupling networks for power supply lines. And directly couples the disturbances signal into EUT.

For signal ports, telecommunication ports, and control ports:

The disturbance signal is through a coupling and decoupling networks (CDN) or EM-clamp device couples to the signal and telecommunication lines of the EUT.

	Condition of Test	Remarks
1.	Field Strength	3V
2.	Radiated Signal	AM 80% Modulated with 1kHz
3.	Scanning Frequency	0.15 - 80MHz
4.	Dwell Time	3 Seconds
5.	Frequency Step Size Δf	1%

12.4. Test Result

Product	802.11ac Dual Band Module	Temperature	24°C
Test Engineer	Roy Cheng	Relative Humidity	54%
Test Mode	Mode 1	Date of Test	2015/05/16

Frequency (MHz)	Inject Voltage (V)	Inject Ports	Inject Method	Observation	Result
0.15-80	3	AC Mains	CDN	Note	Pass

Note: There is no any degradation of performance and function, and the EUT performance complied with performance criteria for CT&CR to MS Function.

12.5. Test Photograph

Test Mode: Mode 1

Description: Radio-frequency Common Mode Test Setup



13. Voltage Dips and Interruptions

13.1. Limit of Voltage Dips and Interruptions

Environmental phenomenon	Test specification	Units	Performance criterion
Input AC power ports			
Voltage dips	0	% residual	B
	0.5	cycle	
	0	% residual	B
	1	cycle	
Voltage interruptions	70	% residual	C
	25	cycle	
Voltage interruptions	0	% residual	C
	250	cycle	

13.2. Test Setup

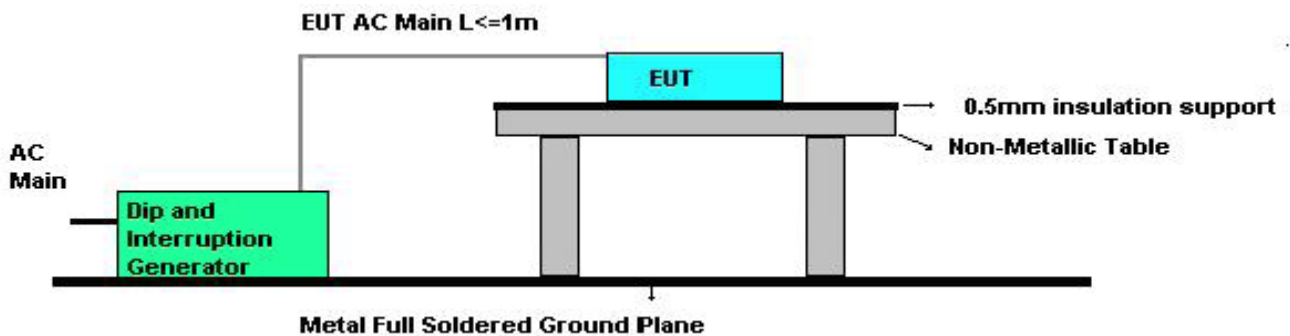

13.3. Test Procedure

The EUT is placed on a table which is 0.8 meter above a metal ground plane measured 1m*1m minimum, and 0.65mm thick minimum, and projected beyond the EUT by at least 0.1m on all sides. The power cord shall be used the shortest power cord as specified by the manufacturer.

For Voltage dips and interruptions test:

The selection of test voltage is based on the rated power range. If the operation range is large than 20% of lower power range, both end of specified voltage shall be tested. Otherwise, the typical voltage specification is selected as test voltage.

The EUT is connected to the power mains through a coupling device that directly couples to the voltage dips and interruption generator.

13.4. Test Result

Product	802.11ac Dual Band Module	Temperature	24°C
Test Engineer	Roy Cheng	Relative Humidity	54%
Test Mode	Mode 1	Date of Test	2015/05/16

Voltage % Residual	Test Duration (ms)	Observation	Result
0	10	Note 1	Pass
0	20	Note 1	Pass
70	500	Note 1	Pass
0	5000	Note 2	Pass

Note1: There is no any degradation of performance and function, and the EUT performance complied with performance criteria for TT&TR to MS Function.

Note 2: The system shut down during the test, but the function can be restored by the operation after the test, and the EUT performance complied with performance criteria for TT&TR to MS Function.

13.5. Test Photograph

Test Mode: Mode 1

Description: Voltage dips and interruptions Test Setup



14. Uncertainty Measurement

Conducted Emission
The maximum measurement uncertainty is evaluated as: 9kHz~150kHz: 3.84dB 150kHz~30MHz: 3.46dB
Radiated disturbance
The maximum measurement uncertainty is evaluated as: Horizontal: 30MHz~300MHz: 4.07dB 300MHz~1GHz: 3.63 dB Vertical: 30MHz~300MHz: 4.18 dB 300MHz~1GHz: 3.60 dB
Radiated disturbance
The maximum measurement uncertainty is evaluated as: Horizontal: 1GHz~18GHz: 4.16 dB Vertical: 1GHz~18GHz: 4.76 dB
Harmonic current emissions
The maximum measurement uncertainty is evaluated as $\pm 0.2\%$.
Voltage fluctuation and flicker
The maximum measurement uncertainty is evaluated as d_c and d_{max} : $\pm 0.095\%$, P_{st} and P_{lt} : $\pm 4\%$, $d_{(t)}$: $\pm 1.5\%$.
Electrostatic discharge
The maximum measurement uncertainty is evaluated as Voltage: $\pm 1\%$, Time: $\pm 6.4\%$.
Radio-frequency electromagnetic field
The maximum measurement uncertainty is evaluated as $\pm 2.72\text{dB}$.
Fast transients
The maximum measurement uncertainty is evaluated as Voltage: $\pm 4\%$, Time: $\pm 3\%$.
Surges
The maximum measurement uncertainty is evaluated as Voltage: $\pm 4\%$, Time: $\pm 2\%$.
Radio-frequency common mode
The maximum measurement uncertainty is evaluated as $\pm 3.72\text{dB}$.
Voltage dips and interruptions
The maximum measurement uncertainty is evaluated as Voltage: $\pm 4\%$, Time: $\pm 1\%$.

15. List of Measuring Instrument

Conducted Emission

Instrument	Manufacturer	Type No.	Asset No.	Cali. Interval	Cali. Due Date
EMI Test Receiver	R&S	ESR7	MRTSUE06001	1 year	2015/11/07
Two-Line V-Network	R&S	ENV216	MRTSUE06002	1 year	2015/11/07
Two-Line V-Network	R&S	ENV216	MRTSUE06003	1 year	2015/11/07
Temperature/Humidity Meter	Anymetre	TH101B	MRTSUE06045	1 year	2015/11/14

Radiated Disturbance

Instrument	Manufacturer	Type No.	Asset No.	Cali. Interval	Cali. Due Date
EMI Test Receiver	R&S	ESR7	MRTSUE06001	1 year	2015/11/07
TRILOG Antenna	Schwarzbeck	VULB9162	MRTSUE06022	1 year	2015/11/08
Broad-Band Horn Antenna	Schwarzbeck	BBHA9120D	MRTSUE06023	1 year	2015/11/08
Preamplifier	Agilent	83017A	MRTSUE06019	1 year	2015/12/13
Temperature/Humidity Meter	Anymetre	TH101B	MRTSUE06048	1 year	2015/11/14

Harmonic Current Emissions

Instrument	Manufacturer	Type No.	Asset No.	Cali. Interval	Cali. Due Date
Power Analyzer	California	PACS-1	MRTSUE06010	1 year	2016/01/02
AC Power Source	California	3001iX	MRTSUE06011	1 year	2016/01/02

Voltage Fluctuation and Flicker

Instrument	Manufacturer	Type No.	Asset No.	Cali. Interval	Cali. Due Date
Power Analyzer	California	PACS-1	MRTSUE06010	1 year	2016/01/02
AC Power Source	California	3001iX	MRTSUE06011	1 year	2016/01/02

Electrostatic Discharge

Instrument	Manufacturer	Type No.	Asset No.	Cali. Interval	Cali. Due Date
ESD Simulator	Teseq GmbH	NSG 435	MRTSUE06031	1 year	2015/11/11
Barometer	BaoPing	DYM3	MRTSUE06044	1 year	2015/11/11
Temperature/Humidity Meter	Anymetre	TH101B	MRTSUE06049	1 year	2015/11/15

Radio-frequency Electromagnetic Field

Instrument	Manufacturer	Type No.	Cali. Interval	Cali. Due Date
Signal Generator	R&S	SML03	1 year	2015/09/16
Power Meter	Boonton	4231A	1 year	2015/09/16
Power Sensor	Boonton	51011-EMC	1 year	2015/09/16
Power Meter	Agilent	E4416A	1 year	2015/09/16
Power Sensor	Agilent	E9304A	1 year	2015/09/16
RF Switch	MF	SW1072	1 year	N/A
Power Amplifier	Schaffner	CBA9413B	1 year	NA
Power Amplifier	Schaffner	CBA9428	1 year	NA
Directional Coupler	Schaffner	CHA 9652B	1 year	N/A
Directional Coupler	A&R	DC7144A	1 year	N/A
E-Field Probe Type 8.3	Narda	2244/90.21	1 year	2016/03/28
EMR-20C Radiation Meter	Narda	BN 2244/70	1 year	2016/03/28
Bilog Antenna	Schaffner	CBL6141A	1 year	N/A
Horn Antenna	A&R	AT4002A	1 year	N/A
Temperature/Humidity Meter	Zhicheng	ZC1-2	1 year	2016/01/11

Fast Transients

Instrument	Manufacturer	Type No.	Asset No.	Cali. Interval	Cali. Due Date
Compact Immunity Test System	3cTest	CCS 600	MRTSUE06033	N/A	N/A
Oscilloscope	Agilent	DSO-X 6002A	MRTSUE06107	1 year	2016/05/08
Temperature/Humidity Meter	Anymetre	TH101B	MRTSUE06043	1 year	2015/11/14

Surges

Instrument	Manufacturer	Type No.	Asset No.	Cali. Interval	Cali. Due Date
Compact Immunity Test System	3cTest	CCS 600	MRTSUE06033	N/A	N/A
CDN	3cTest	CDN-405T8	MRTSUE06037	N/A	N/A
Oscilloscope	Agilent	DSO-X 6002A	MRTSUE06107	1 year	2016/05/08

Radio-frequency Common Mode

Instrument	Manufacturer	Type No.	Asset No.	Cali. Interval	Cali. Due Date
Conducted Immunity Tester	Frankonia	CIT-10/75	MRTSUE06038	N/A	N/A
CDN	Frankonia	CDN M2+M3	MRTSUE06039	N/A	N/A
Oscilloscope	Agilent	DSO-X 6002A	MRTSUE06107	1 year	2016/05/08
Temperature/Humidity Meter	Anymetre	TH101B	MRTSUE06043	1 year	2015/11/14

Voltage Dips and Interruptions

Instrument	Manufacturer	Type No.	Asset No.	Cali. Interval	Cali. Due Date
Compact Immunity Test System	3cTest	CCS 600	MRTSUE06033	N/A	N/A
CDN	3cTest	VMT 2612S	MRTSUE06034	N/A	N/A
Oscilloscope	Agilent	DSO-X 6002A	MRTSUE06107	1 year	2016/05/08
Temperature/Humidity Meter	Anymetre	TH101B	MRTSUE06043	1 year	2015/11/14

Software	Version	Function
e3	V 8.3.5	EMI Test Software
Compliance Test System	V 3.2.0.35	Harmonic & Flicker

16. Appendix - EUT Photograph

(1) EUT Photo

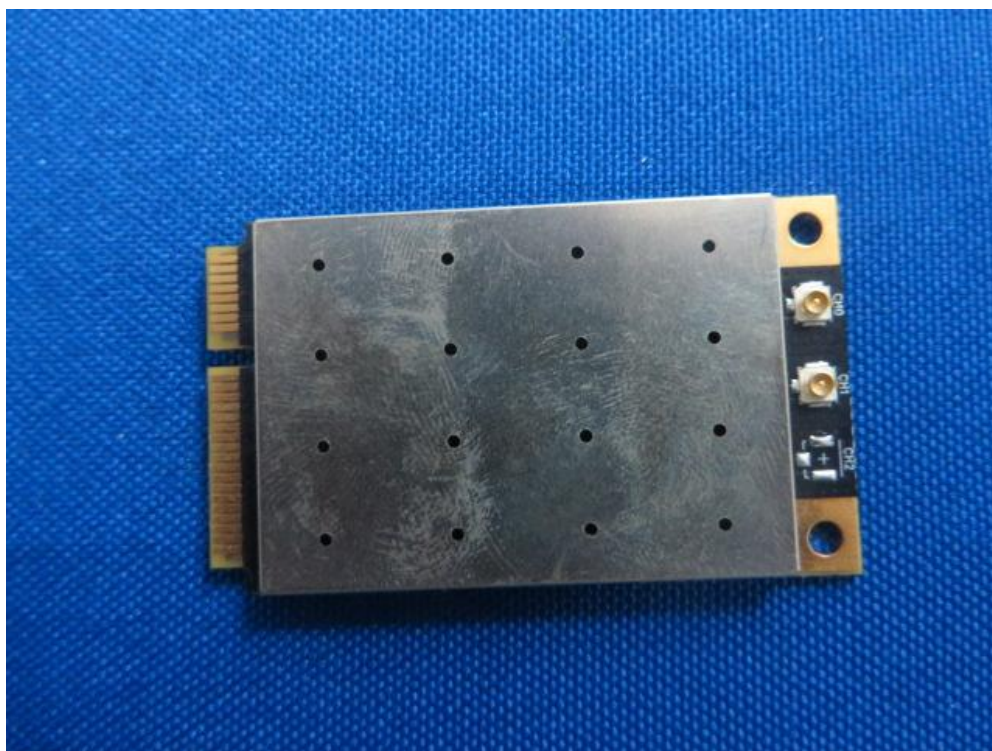

(2) EUT Photo

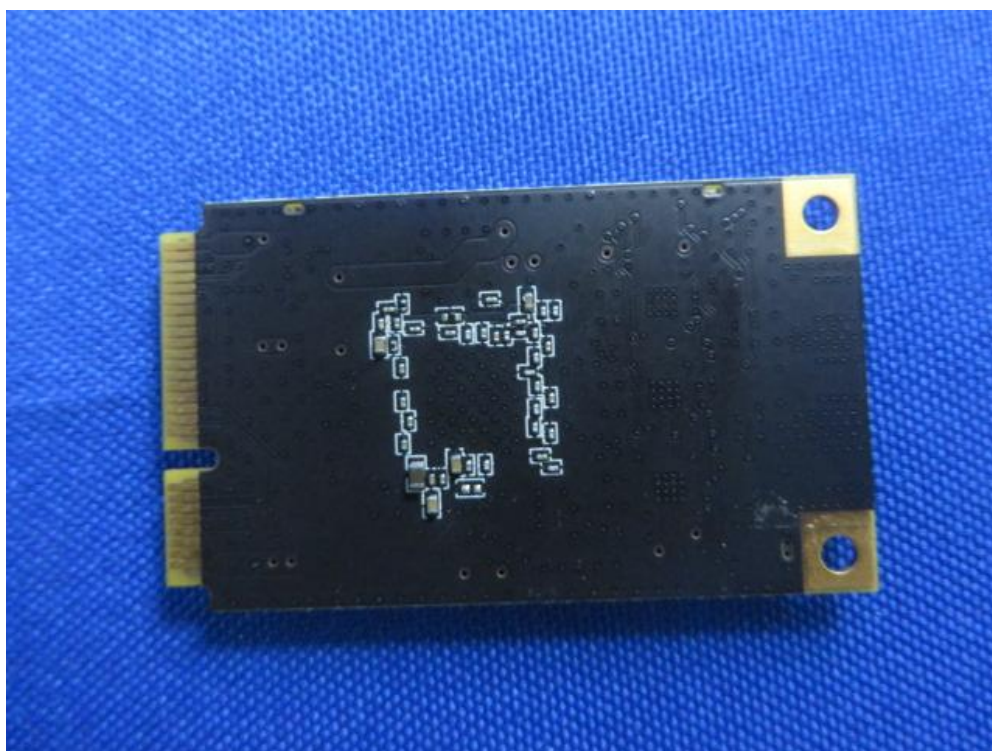

(3) EUT Photo



(4) EUT Photo

